

## LM35 Precision Centigrade Temperature Sensors

### 1 Features

- Calibrated Directly in Celsius (Centigrade)
- Linear + 10-mV/°C Scale Factor
- 0.5°C Ensured Accuracy (at 25°C)
- Rated for Full –55°C to 150°C Range
- Suitable for Remote Applications
- Low-Cost Due to Wafer-Level Trimming
- Operates From 4 V to 30 V
- Less Than 60- $\mu$ A Current Drain
- Low Self-Heating, 0.08°C in Still Air
- Non-Linearity Only  $\pm 1/4^\circ\text{C}$  Typical
- Low-Impedance Output, 0.1  $\Omega$  for 1-mA Load

### 2 Applications

- Power Supplies
- Battery Management
- HVAC
- Appliances

### 3 Description

The LM35 series are precision integrated-circuit temperature devices with an output voltage linearly-proportional to the Centigrade temperature. The LM35 device has an advantage over linear temperature sensors calibrated in Kelvin, as the user is not required to subtract a large constant voltage from the output to obtain convenient Centigrade scaling. The LM35 device does not require any external calibration or trimming to provide typical accuracies of  $\pm 1/4^\circ\text{C}$  at room temperature and  $\pm 3/4^\circ\text{C}$  over a full –55°C to 150°C temperature range. Lower cost is assured by trimming and calibration at the wafer level. The low-output impedance, linear output, and precise inherent calibration of the LM35 device makes interfacing to readout or control circuitry especially easy. The device is used with single power supplies, or with plus and minus supplies. As the LM35 device draws only 60  $\mu\text{A}$  from the supply, it has very low self-heating of less than 0.1°C in still air. The LM35 device is rated to operate over a –55°C to 150°C temperature range, while the LM35C device is rated for a –40°C to 110°C range ( $-10^\circ$  with improved accuracy). The LM35-series devices are available packaged in hermetic TO transistor packages, while the LM35C, LM35CA, and LM35D devices are available in the plastic TO-92 transistor package. The LM35D device is available in an 8-lead surface-mount small-outline package and a plastic TO-220 package.

#### Device Information<sup>(1)</sup>

PART NUMBER	PACKAGE	BODY SIZE (NOM)
LM35	TO-CAN (3)	4.699 mm × 4.699 mm
	TO-92 (3)	4.30 mm × 4.30 mm
	SOIC (8)	4.90 mm × 3.91 mm
	TO-220 (3)	14.986 mm × 10.16 mm

(1) For all available packages, see the orderable addendum at the end of the datasheet.

#### Basic Centigrade Temperature Sensor (2°C to 150°C)

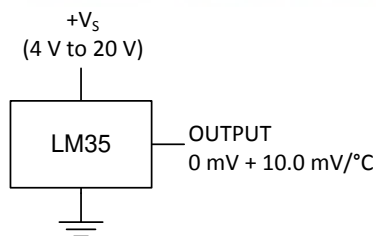

#### Full-Range Centigrade Temperature Sensor

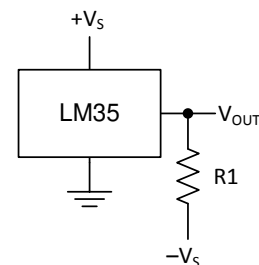

Choose  $R_1 = -V_S / 50 \mu\text{A}$   
 $V_{\text{OUT}} = 1500 \text{ mV}$  at 150°C  
 $V_{\text{OUT}} = 250 \text{ mV}$  at 25°C  
 $V_{\text{OUT}} = -550 \text{ mV}$  at –55°C



## Table of Contents

<b>1 Features</b> .....	1	7.3 Feature Description .....	13
<b>2 Applications</b> .....	1	7.4 Device Functional Modes .....	13
<b>3 Description</b> .....	1	<b>8 Application and Implementation</b> .....	14
<b>4 Revision History</b> .....	2	8.1 Application Information .....	14
<b>5 Pin Configuration and Functions</b> .....	3	8.2 Typical Application .....	15
<b>6 Specifications</b> .....	4	8.3 System Examples .....	16
6.1 Absolute Maximum Ratings .....	4	<b>9 Power Supply Recommendations</b> .....	19
6.2 ESD Ratings .....	4	<b>10 Layout</b> .....	19
6.3 Recommended Operating Conditions .....	4	10.1 Layout Guidelines .....	19
6.4 Thermal Information .....	4	10.2 Layout Example .....	20
6.5 Electrical Characteristics: LM35A, LM35CA Limits ...	5	<b>11 Device and Documentation Support</b> .....	21
6.6 Electrical Characteristics: LM35A, LM35CA .....	6	11.1 Receiving Notification of Documentation Updates	21
6.7 Electrical Characteristics: LM35, LM35C, LM35D Limits .....	8	11.2 Community Resources .....	21
6.8 Electrical Characteristics: LM35, LM35C, LM35D ...	9	11.3 Trademarks .....	21
6.9 Typical Characteristics .....	11	11.4 Electrostatic Discharge Caution .....	21
<b>7 Detailed Description</b> .....	13	11.5 Glossary .....	21
7.1 Overview .....	13	<b>12 Mechanical, Packaging, and Orderable Information</b> .....	21
7.2 Functional Block Diagram .....	13		

## 4 Revision History

Changes from Revision G (August 2016) to Revision H	Page
• Changed NDV Package (TO-CAN) pinout from bottom view back to top view; added textnote to pinout .....	3
• Added pin numbers to the TO-CAN (TO46) pinout .....	3
Changes from Revision F (January 2016) to Revision G	Page
• <a href="#">Equation 1</a> , changed From: 10 mV/°F To: 10mV/°C .....	13
• <a href="#">Power Supply Recommendations</a> , changed From: "4-V to 5.5-V power supply" To: "4-V to 30-V power supply: .....	19
Changes from Revision E (January 2015) to Revision F	Page
• Changed NDV Package (TO-CAN) pinout from Top View to Bottom View .....	3
Changes from Revision D (October 2013) to Revision E	Page
• Added <i>Pin Configuration and Functions</i> section, <i>ESD Ratings</i> table, <i>Feature Description</i> section, <i>Device Functional Modes</i> , <i>Application and Implementation</i> section, <i>Power Supply Recommendations</i> section, <i>Layout</i> section, <i>Device and Documentation Support</i> section, and <i>Mechanical, Packaging, and Orderable Information</i> section .....	1
Changes from Revision C (July 2013) to Revision D	Page
• Changed <i>W</i> to $\Omega$ .....	1
• Changed <i>W</i> to $\Omega$ in <i>Abs Max</i> tablenote. ....	4

## 5 Pin Configuration and Functions

**NDV Package  
3-Pin TO-CAN  
(Top View)**

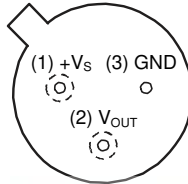

Case is connected to negative pin (GND)

Refer the second NDV0003H page for reference

**LP Package  
3-Pin TO-92  
(Bottom View)**

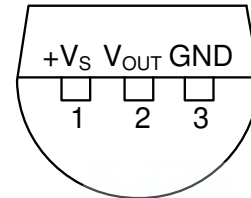

**D Package  
8-PIN SOIC  
(Top View)**

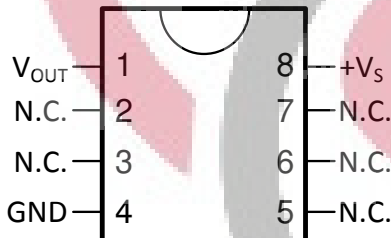

N.C. = No connection

**NEB Package  
3-Pin TO-220  
(Top View)**

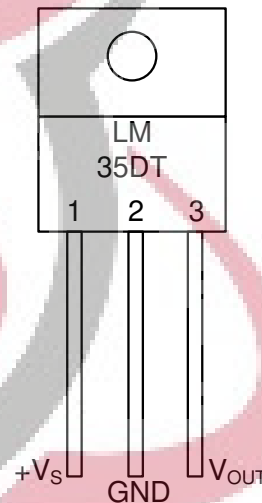

Tab is connected to the negative pin (GND).

**NOTE:** The LM35DT pinout is different than the discontinued LM35DP

### Pin Functions

NAME	PIN				TYPE	DESCRIPTION
	TO46	TO92	TO220	SO8		
V <sub>OUT</sub>	2	2	3	1	O	Temperature Sensor Analog Output
N.C.	—	—	—	2	—	No Connection
	—	—	—	3		
GND	3	3	2	4	GROUND	Device ground pin, connect to power supply negative terminal
N.C.	—	—	—	5	—	No Connection
	—	—	—	6		
	—	—	—	7		
+V <sub>S</sub>	1	1	1	8	POWER	Positive power supply pin

## 6 Specifications

### 6.1 Absolute Maximum Ratings

over operating free-air temperature range (unless otherwise noted)<sup>(1)(2)</sup>

		MIN	MAX	UNIT
Supply voltage		-0.2	35	V
Output voltage		-1	6	V
Output current			10	mA
Maximum Junction Temperature, $T_{jmax}$			150	°C
Storage Temperature, $T_{stg}$	TO-CAN, TO-92 Package	-60	150	°C
	TO-220, SOIC Package	-65	150	

- (1) If Military/Aerospace specified devices are required, please contact the Texas Instruments Sales Office/ Distributors for availability and specifications.
- (2) Absolute Maximum Ratings indicate limits beyond which damage to the device may occur. DC and AC electrical specifications do not apply when operating the device beyond its rated operating conditions.

### 6.2 ESD Ratings

			VALUE	UNIT
$V_{(ESD)}$	Electrostatic discharge	Human-body model (HBM), per ANSI/ESDA/JEDEC JS-001 <sup>(1)</sup>	±2500	V

- (1) JEDEC document JEP155 states that 500-V HBM allows safe manufacturing with a standard ESD control process.

### 6.3 Recommended Operating Conditions

over operating free-air temperature range (unless otherwise noted)

		MIN	MAX	UNIT
Specified operating temperature: $T_{MIN}$ to $T_{MAX}$	LM35, LM35A	-55	150	°C
	LM35C, LM35CA	-40	110	
	LM35D	0	100	
Supply Voltage (+ $V_S$ )		4	30	V

### 6.4 Thermal Information

THERMAL METRIC <sup>(1)(2)</sup>	LM35				UNIT
	NDV	LP	D	NEB	
	3 PINS		8 PINS	3 PINS	
$R_{\theta JA}$ Junction-to-ambient thermal resistance	400	180	220	90	°C/W
$R_{\theta JC(top)}$ Junction-to-case (top) thermal resistance	24	—	—	—	

- (1) For more information about traditional and new thermal metrics, see the *IC Package Thermal Metrics* application report, [SPRA953](#).
- (2) For additional thermal resistance information, see [Typical Application](#).

## 6.5 Electrical Characteristics: LM35A, LM35CA Limits

Unless otherwise noted, these specifications apply:  $-55^{\circ}\text{C} \leq T_J \leq 150^{\circ}\text{C}$  for the LM35 and LM35A;  $-40^{\circ}\text{C} \leq T_J \leq 110^{\circ}\text{C}$  for the LM35C and LM35CA; and  $0^{\circ}\text{C} \leq T_J \leq 100^{\circ}\text{C}$  for the LM35D.  $V_S = 5\text{ Vdc}$  and  $I_{\text{LOAD}} = 50\ \mu\text{A}$ , in the circuit of [Full-Range Centigrade Temperature Sensor](#). These specifications also apply from  $2^{\circ}\text{C}$  to  $T_{\text{MAX}}$  in the circuit of [Figure 14](#).

PARAMETER	TEST CONDITIONS	LM35A			LM35CA			UNIT
		TYP	TESTED LIMIT <sup>(1)</sup>	DESIGN LIMIT <sup>(2)</sup>	TYP	TESTED LIMIT <sup>(1)</sup>	DESIGN LIMIT <sup>(2)</sup>	
Accuracy <sup>(3)</sup>	$T_A = 25^{\circ}\text{C}$	$\pm 0.2$	$\pm 0.5$		$\pm 0.2$	$\pm 0.5$		$^{\circ}\text{C}$
	$T_A = -10^{\circ}\text{C}$	$\pm 0.3$			$\pm 0.3$		$\pm 1$	
	$T_A = T_{\text{MAX}}$	$\pm 0.4$	$\pm 1$		$\pm 0.4$	$\pm 1$		
	$T_A = T_{\text{MIN}}$	$\pm 0.4$	$\pm 1$		$\pm 0.4$		$\pm 1.5$	
Nonlinearity <sup>(4)</sup>	$T_{\text{MIN}} \leq T_A \leq T_{\text{MAX}}$ , $-40^{\circ}\text{C} \leq T_J \leq 125^{\circ}\text{C}$	$\pm 0.18$		$\pm 0.35$	$\pm 0.15$		$\pm 0.3$	$^{\circ}\text{C}$
Sensor gain (average slope)	$T_{\text{MIN}} \leq T_A \leq T_{\text{MAX}}$	10	9.9		10		9.9	$\text{mV}/^{\circ}\text{C}$
	$-40^{\circ}\text{C} \leq T_J \leq 125^{\circ}\text{C}$	10	10.1		10		10.1	
Load regulation <sup>(5)</sup> $0 \leq I_L \leq 1\ \text{mA}$	$T_A = 25^{\circ}\text{C}$	$\pm 0.4$	$\pm 1$		$\pm 0.4$	$\pm 1$		$\text{mV}/\text{mA}$
	$T_{\text{MIN}} \leq T_A \leq T_{\text{MAX}}$ , $-40^{\circ}\text{C} \leq T_J \leq 125^{\circ}\text{C}$	$\pm 0.5$		$\pm 3$	$\pm 0.5$		$\pm 3$	
Line regulation <sup>(5)</sup>	$T_A = 25^{\circ}\text{C}$	$\pm 0.01$	$\pm 0.05$		$\pm 0.01$	$\pm 0.05$		$\text{mV}/\text{V}$
	$4\ \text{V} \leq V_S \leq 30\ \text{V}$ , $-40^{\circ}\text{C} \leq T_J \leq 125^{\circ}\text{C}$	$\pm 0.02$		$\pm 0.1$	$\pm 0.02$		$\pm 0.1$	
Quiescent current <sup>(6)</sup>	$V_S = 5\ \text{V}$ , $25^{\circ}\text{C}$	56	67		56	67		$\mu\text{A}$
	$V_S = 5\ \text{V}$ , $-40^{\circ}\text{C} \leq T_J \leq 125^{\circ}\text{C}$	105		131	91		114	
	$V_S = 30\ \text{V}$ , $25^{\circ}\text{C}$	56.2	68		56.2	68		
	$V_S = 30\ \text{V}$ , $-40^{\circ}\text{C} \leq T_J \leq 125^{\circ}\text{C}$	105.5		133	91.5		116	
Change of quiescent current <sup>(5)</sup>	$4\ \text{V} \leq V_S \leq 30\ \text{V}$ , $25^{\circ}\text{C}$	0.2	1		0.2	1		$\mu\text{A}$
	$4\ \text{V} \leq V_S \leq 30\ \text{V}$ , $-40^{\circ}\text{C} \leq T_J \leq 125^{\circ}\text{C}$	0.5		2	0.5		2	
Temperature coefficient of quiescent current	$-40^{\circ}\text{C} \leq T_J \leq 125^{\circ}\text{C}$	0.39		0.5	0.39		0.5	$\mu\text{A}/^{\circ}\text{C}$
Minimum temperature for rate accuracy	In circuit of <a href="#">Figure 14</a> , $I_L = 0$	1.5		2	1.5		2	$^{\circ}\text{C}$
Long term stability	$T_J = T_{\text{MAX}}$ , for 1000 hours	$\pm 0.08$			$\pm 0.08$			$^{\circ}\text{C}$

- (1) Tested Limits are ensured and 100% tested in production.
- (2) Design Limits are ensured (but not 100% production tested) over the indicated temperature and supply voltage ranges. These limits are not used to calculate outgoing quality levels.
- (3) Accuracy is defined as the error between the output voltage and  $10\ \text{mV}/^{\circ}\text{C}$  times the case temperature of the device, at specified conditions of voltage, current, and temperature (expressed in  $^{\circ}\text{C}$ ).
- (4) Non-linearity is defined as the deviation of the output-voltage-versus-temperature curve from the best-fit straight line, over the rated temperature range of the device.
- (5) Regulation is measured at constant junction temperature, using pulse testing with a low duty cycle. Changes in output due to heating effects can be computed by multiplying the internal dissipation by the thermal resistance.
- (6) Quiescent current is defined in the circuit of [Figure 14](#).

## 6.6 Electrical Characteristics: LM35A, LM35CA

Unless otherwise noted, these specifications apply:  $-55^{\circ}\text{C} \leq T_J \leq 150^{\circ}\text{C}$  for the LM35 and LM35A;  $-40^{\circ}\text{C} \leq T_J \leq 110^{\circ}\text{C}$  for the LM35C and LM35CA; and  $0^{\circ}\text{C} \leq T_J \leq 100^{\circ}\text{C}$  for the LM35D.  $V_S = 5\text{ Vdc}$  and  $I_{\text{LOAD}} = 50\ \mu\text{A}$ , in the circuit of [Full-Range Centigrade Temperature Sensor](#). These specifications also apply from  $2^{\circ}\text{C}$  to  $T_{\text{MAX}}$  in the circuit of [Figure 14](#).

PARAMETER	TEST CONDITIONS	LM35A			LM35CA			UNIT	
		MIN	TYP	MAX	TYP	TYP	MAX		
Accuracy <sup>(1)</sup>	$T_A = 25^{\circ}\text{C}$		$\pm 0.2$		$\pm 0.2$			°C	
		Tested Limit <sup>(2)</sup>					$\pm 0.5$		
		Design Limit <sup>(3)</sup>							
	$T_A = -10^{\circ}\text{C}$			$\pm 0.3$		$\pm 0.3$			
		Tested Limit <sup>(2)</sup>							
		Design Limit <sup>(3)</sup>							$\pm 1$
	$T_A = T_{\text{MAX}}$			$\pm 0.4$		$\pm 0.4$			
		Tested Limit <sup>(2)</sup>			$\pm 1$				$\pm 1$
		Design Limit <sup>(3)</sup>							
	$T_A = T_{\text{MIN}}$			$\pm 0.4$		$\pm 0.4$			
		Tested Limit <sup>(2)</sup>			$\pm 1$				
		Design Limit <sup>(3)</sup>							$\pm 1.5$
Nonlinearity <sup>(4)</sup>	$T_{\text{MIN}} \leq T_A \leq T_{\text{MAX}}$ , $-40^{\circ}\text{C} \leq T_J \leq 125^{\circ}\text{C}$		$\pm 0.18$		$\pm 0.15$			°C	
		Tested Limit <sup>(2)</sup>							
		Design Limit <sup>(3)</sup>			$\pm 0.35$		$\pm 0.3$		
Sensor gain (average slope)	$T_{\text{MIN}} \leq T_A \leq T_{\text{MAX}}$		10		10			mV/°C	
		Tested Limit <sup>(2)</sup>			9.9				
		Design Limit <sup>(3)</sup>					9.9		
	$-40^{\circ}\text{C} \leq T_J \leq 125^{\circ}\text{C}$		10		10				
		Tested Limit <sup>(2)</sup>			10.1				
		Design Limit <sup>(3)</sup>					10.1		
Load regulation <sup>(5)</sup> $0 \leq I_L \leq 1\text{ mA}$	$T_A = 25^{\circ}\text{C}$		$\pm 0.4$		$\pm 0.4$			mV/mA	
		Tested Limit <sup>(2)</sup>			$\pm 1$		$\pm 1$		
		Design Limit <sup>(3)</sup>							
	$T_{\text{MIN}} \leq T_A \leq T_{\text{MAX}}$ , $-40^{\circ}\text{C} \leq T_J \leq 125^{\circ}\text{C}$		$\pm 0.5$		$\pm 0.5$				
		Tested Limit <sup>(2)</sup>							
		Design Limit <sup>(3)</sup>			$\pm 3$		$\pm 3$		
Line regulation <sup>(5)</sup>	$T_A = 25^{\circ}\text{C}$		$\pm 0.01$		$\pm 0.01$			mV/V	
		Tested Limit <sup>(2)</sup>			$\pm 0.05$		$\pm 0.05$		
		Design Limit <sup>(3)</sup>							
	$4\text{ V} \leq V_S \leq 30\text{ V}$ , $-40^{\circ}\text{C} \leq T_J \leq 125^{\circ}\text{C}$		$\pm 0.02$		$\pm 0.02$				
		Tested Limit <sup>(2)</sup>							
		Design Limit <sup>(3)</sup>			$\pm 0.1$		$\pm 0.1$		

- (1) Accuracy is defined as the error between the output voltage and 10 mV/°C times the case temperature of the device, at specified conditions of voltage, current, and temperature (expressed in °C).
- (2) Tested Limits are ensured and 100% tested in production.
- (3) Design Limits are ensured (but not 100% production tested) over the indicated temperature and supply voltage ranges. These limits are not used to calculate outgoing quality levels.
- (4) Non-linearity is defined as the deviation of the output-voltage-versus-temperature curve from the best-fit straight line, over the rated temperature range of the device.
- (5) Regulation is measured at constant junction temperature, using pulse testing with a low duty cycle. Changes in output due to heating effects can be computed by multiplying the internal dissipation by the thermal resistance.

**Electrical Characteristics: LM35A, LM35CA (continued)**

Unless otherwise noted, these specifications apply:  $-55^{\circ}\text{C} \leq T_J \leq 150^{\circ}\text{C}$  for the LM35 and LM35A;  $-40^{\circ}\text{C} \leq T_J \leq 110^{\circ}\text{C}$  for the LM35C and LM35CA; and  $0^{\circ}\text{C} \leq T_J \leq 100^{\circ}\text{C}$  for the LM35D.  $V_S = 5\text{ Vdc}$  and  $I_{\text{LOAD}} = 50\ \mu\text{A}$ , in the circuit of [Full-Range Centigrade Temperature Sensor](#). These specifications also apply from  $2^{\circ}\text{C}$  to  $T_{\text{MAX}}$  in the circuit of [Figure 14](#).

PARAMETER	TEST CONDITIONS	LM35A			LM35CA			UNIT	
		MIN	TYP	MAX	TYP	TYP	MAX		
Quiescent current <sup>(6)</sup>	$V_S = 5\text{ V}, 25^{\circ}\text{C}$		56		56			$\mu\text{A}$	
		Tested Limit <sup>(2)</sup>					67		
		Design Limit <sup>(3)</sup>							
	$V_S = 5\text{ V}, -40^{\circ}\text{C} \leq T_J \leq 125^{\circ}\text{C}$			105		91			
		Tested Limit <sup>(2)</sup>							
		Design Limit <sup>(3)</sup>			131				114
	$V_S = 30\text{ V}, 25^{\circ}\text{C}$			56.2		56.2			
		Tested Limit <sup>(2)</sup>							
		Design Limit <sup>(3)</sup>			68				68
	$V_S = 30\text{ V}, -40^{\circ}\text{C} \leq T_J \leq 125^{\circ}\text{C}$			105.5		91.5			
		Tested Limit <sup>(2)</sup>							
		Design Limit <sup>(3)</sup>			133				116
Change of quiescent current <sup>(5)</sup>	$4\text{ V} \leq V_S \leq 30\text{ V}, 25^{\circ}\text{C}$		0.2		0.2			$\mu\text{A}$	
		Tested Limit <sup>(2)</sup>					1		
		Design Limit <sup>(3)</sup>							
	$4\text{ V} \leq V_S \leq 30\text{ V}, -40^{\circ}\text{C} \leq T_J \leq 125^{\circ}\text{C}$			0.5		0.5			
		Tested Limit <sup>(2)</sup>							
		Design Limit <sup>(3)</sup>			2				2
Temperature coefficient of quiescent current	$-40^{\circ}\text{C} \leq T_J \leq 125^{\circ}\text{C}$		0.39		0.39			$\mu\text{A}/^{\circ}\text{C}$	
		Tested Limit <sup>(2)</sup>							
		Design Limit <sup>(3)</sup>			0.5		0.5		
Minimum temperature for rate accuracy	In circuit of <a href="#">Figure 14</a> , $I_L = 0$		1.5		1.5			$^{\circ}\text{C}$	
		Tested Limit <sup>(2)</sup>							
		Design Limit <sup>(3)</sup>			2		2		
Long term stability	$T_J = T_{\text{MAX}}$ , for 1000 hours		$\pm 0.08$		$\pm 0.08$			$^{\circ}\text{C}$	

(6) Quiescent current is defined in the circuit of [Figure 14](#).



## 6.7 Electrical Characteristics: LM35, LM35C, LM35D Limits

Unless otherwise noted, these specifications apply:  $-55^{\circ}\text{C} \leq T_J \leq 150^{\circ}\text{C}$  for the LM35 and LM35A;  $-40^{\circ}\text{C} \leq T_J \leq 110^{\circ}\text{C}$  for the LM35C and LM35CA; and  $0^{\circ}\text{C} \leq T_J \leq 100^{\circ}\text{C}$  for the LM35D.  $V_S = 5\text{ Vdc}$  and  $I_{\text{LOAD}} = 50\ \mu\text{A}$ , in the circuit of [Full-Range Centigrade Temperature Sensor](#). These specifications also apply from  $2^{\circ}\text{C}$  to  $T_{\text{MAX}}$  in the circuit of [Figure 14](#).

PARAMETER	TEST CONDITIONS	LM35			LM35C, LM35D			UNIT
		TYP	TESTED LIMIT <sup>(1)</sup>	DESIGN LIMIT <sup>(2)</sup>	TYP	TESTED LIMIT <sup>(1)</sup>	DESIGN LIMIT <sup>(2)</sup>	
Accuracy, LM35, LM35C <sup>(3)</sup>	$T_A = 25^{\circ}\text{C}$	$\pm 0.4$	$\pm 1$		$\pm 0.4$	$\pm 1$		$^{\circ}\text{C}$
	$T_A = -10^{\circ}\text{C}$	$\pm 0.5$			$\pm 0.5$		$\pm 1.5$	
	$T_A = T_{\text{MAX}}$	$\pm 0.8$	$\pm 1.5$		$\pm 0.8$		$\pm 1.5$	
	$T_A = T_{\text{MIN}}$	$\pm 0.8$		$\pm 1.5$	$\pm 0.8$		$\pm 2$	
Accuracy, LM35D <sup>(3)</sup>	$T_A = 25^{\circ}\text{C}$				$\pm 0.6$	$\pm 1.5$		$^{\circ}\text{C}$
	$T_A = T_{\text{MAX}}$				$\pm 0.9$		$\pm 2$	
	$T_A = T_{\text{MIN}}$				$\pm 0.9$		$\pm 2$	
Nonlinearity <sup>(4)</sup>	$T_{\text{MIN}} \leq T_A \leq T_{\text{MAX}}$ , $-40^{\circ}\text{C} \leq T_J \leq 125^{\circ}\text{C}$	$\pm 0.3$		$\pm 0.5$	$\pm 0.2$		$\pm 0.5$	$^{\circ}\text{C}$
Sensor gain (average slope)	$T_{\text{MIN}} \leq T_A \leq T_{\text{MAX}}$ , $-40^{\circ}\text{C} \leq T_J \leq 125^{\circ}\text{C}$	10	9.8		10		9.8	mV/ $^{\circ}\text{C}$
		10	10.2		10		10.2	
Load regulation <sup>(5)</sup> $0 \leq I_L \leq 1\text{ mA}$	$T_A = 25^{\circ}\text{C}$	$\pm 0.4$	$\pm 2$		$\pm 0.4$	$\pm 2$		mV/mA
	$T_{\text{MIN}} \leq T_A \leq T_{\text{MAX}}$ , $-40^{\circ}\text{C} \leq T_J \leq 125^{\circ}\text{C}$	$\pm 0.5$		$\pm 5$	$\pm 0.5$		$\pm 5$	
Line regulation <sup>(5)</sup>	$T_A = 25^{\circ}\text{C}$	$\pm 0.01$	$\pm 0.1$		$\pm 0.01$	$\pm 0.1$		mV/V
	$4\text{ V} \leq V_S \leq 30\text{ V}$ , $-40^{\circ}\text{C} \leq T_J \leq 125^{\circ}\text{C}$	$\pm 0.02$		$\pm 0.2$	$\pm 0.02$		$\pm 0.2$	
Quiescent current <sup>(6)</sup>	$V_S = 5\text{ V}$ , $25^{\circ}\text{C}$	56	80		56	80		$\mu\text{A}$
	$V_S = 5\text{ V}$ , $-40^{\circ}\text{C} \leq T_J \leq 125^{\circ}\text{C}$	105		158	91		138	
	$V_S = 30\text{ V}$ , $25^{\circ}\text{C}$	56.2	82		56.2	82		
	$V_S = 30\text{ V}$ , $-40^{\circ}\text{C} \leq T_J \leq 125^{\circ}\text{C}$	105.5		161	91.5		141	
Change of quiescent current <sup>(5)</sup>	$4\text{ V} \leq V_S \leq 30\text{ V}$ , $25^{\circ}\text{C}$	0.2	2		0.2	2		$\mu\text{A}$
	$4\text{ V} \leq V_S \leq 30\text{ V}$ , $-40^{\circ}\text{C} \leq T_J \leq 125^{\circ}\text{C}$	0.5		3	0.5		3	
Temperature coefficient of quiescent current	$-40^{\circ}\text{C} \leq T_J \leq 125^{\circ}\text{C}$	0.39		0.7	0.39		0.7	$\mu\text{A}/^{\circ}\text{C}$
Minimum temperature for rate accuracy	In circuit of <a href="#">Figure 14</a> , $I_L = 0$	1.5		2	1.5		2	$^{\circ}\text{C}$
Long term stability	$T_J = T_{\text{MAX}}$ , for 1000 hours	$\pm 0.08$			$\pm 0.08$			$^{\circ}\text{C}$

(1) Tested Limits are ensured and 100% tested in production.

(2) Design Limits are ensured (but not 100% production tested) over the indicated temperature and supply voltage ranges. These limits are not used to calculate outgoing quality levels.

(3) Accuracy is defined as the error between the output voltage and  $10\text{ mV}/^{\circ}\text{C}$  times the case temperature of the device, at specified conditions of voltage, current, and temperature (expressed in  $^{\circ}\text{C}$ ).

(4) Non-linearity is defined as the deviation of the output-voltage-versus-temperature curve from the best-fit straight line, over the rated temperature range of the device.

(5) Regulation is measured at constant junction temperature, using pulse testing with a low duty cycle. Changes in output due to heating effects can be computed by multiplying the internal dissipation by the thermal resistance.

(6) Quiescent current is defined in the circuit of [Figure 14](#).

## 6.8 Electrical Characteristics: LM35, LM35C, LM35D

Unless otherwise noted, these specifications apply:  $-55^{\circ}\text{C} \leq T_J \leq 150^{\circ}\text{C}$  for the LM35 and LM35A;  $-40^{\circ}\text{C} \leq T_J \leq 110^{\circ}\text{C}$  for the LM35C and LM35CA; and  $0^{\circ}\text{C} \leq T_J \leq 100^{\circ}\text{C}$  for the LM35D.  $V_S = 5\text{ Vdc}$  and  $I_{\text{LOAD}} = 50\ \mu\text{A}$ , in the circuit of [Full-Range Centigrade Temperature Sensor](#). These specifications also apply from  $2^{\circ}\text{C}$  to  $T_{\text{MAX}}$  in the circuit of [Figure 14](#).

PARAMETER	TEST CONDITIONS		LM35			LM35C, LM35D			UNIT	
			MIN	TYP	MAX	MIN	TYP	MAX		
Accuracy, LM35, LM35C <sup>(1)</sup>	$T_A = 25^{\circ}\text{C}$			$\pm 0.4$			$\pm 0.4$	°C		
		Tested Limit <sup>(2)</sup>					$\pm 1$			
		Design Limit <sup>(3)</sup>					$\pm 1$			
	$T_A = -10^{\circ}\text{C}$				$\pm 0.5$				$\pm 0.5$	
		Tested Limit <sup>(2)</sup>							$\pm 1.5$	
		Design Limit <sup>(3)</sup>							$\pm 1.5$	
	$T_A = T_{\text{MAX}}$				$\pm 0.8$				$\pm 0.8$	
		Tested Limit <sup>(2)</sup>							$\pm 1.5$	
	$T_A = T_{\text{MIN}}$				$\pm 0.8$				$\pm 0.8$	
		Design Limit <sup>(3)</sup>							$\pm 2$	
	Accuracy, LM35D <sup>(1)</sup>	$T_A = 25^{\circ}\text{C}$							$\pm 0.6$	°C
			Tested Limit <sup>(2)</sup>						$\pm 1.5$	
Design Limit <sup>(3)</sup>								$\pm 1.5$		
$T_A = T_{\text{MAX}}$								$\pm 0.9$		
		Tested Limit <sup>(2)</sup>						$\pm 2$		
$T_A = T_{\text{MIN}}$								$\pm 0.9$		
Nonlinearity <sup>(4)</sup>	$T_{\text{MIN}} \leq T_A \leq T_{\text{MAX}},$ $-40^{\circ}\text{C} \leq T_J \leq 125^{\circ}\text{C}$			$\pm 0.3$			$\pm 0.2$	°C		
		Design Limit <sup>(3)</sup>					$\pm 0.5$			
Sensor gain (average slope)	$T_{\text{MIN}} \leq T_A \leq T_{\text{MAX}},$ $-40^{\circ}\text{C} \leq T_J \leq 125^{\circ}\text{C}$			10			10	mV/°C		
		Tested Limit <sup>(2)</sup>					9.8			
		Design Limit <sup>(3)</sup>							9.8	
					10				10	
		Tested Limit <sup>(2)</sup>							10.2	
		Design Limit <sup>(3)</sup>							10.2	
Load regulation <sup>(5)</sup> $0 \leq I_L \leq 1\text{ mA}$	$T_A = 25^{\circ}\text{C}$			$\pm 0.4$			$\pm 0.4$	mV/mA		
		Tested Limit <sup>(2)</sup>					$\pm 2$			
		Design Limit <sup>(3)</sup>							$\pm 2$	
	$T_{\text{MIN}} \leq T_A \leq T_{\text{MAX}},$ $-40^{\circ}\text{C} \leq T_J \leq 125^{\circ}\text{C}$			$\pm 0.5$			$\pm 0.5$			
		Tested Limit <sup>(2)</sup>							$\pm 5$	
		Design Limit <sup>(3)</sup>							$\pm 5$	

- (1) Accuracy is defined as the error between the output voltage and 10 mV/°C times the case temperature of the device, at specified conditions of voltage, current, and temperature (expressed in °C).
- (2) Tested Limits are ensured and 100% tested in production.
- (3) Design Limits are ensured (but not 100% production tested) over the indicated temperature and supply voltage ranges. These limits are not used to calculate outgoing quality levels.
- (4) Non-linearity is defined as the deviation of the output-voltage-versus-temperature curve from the best-fit straight line, over the rated temperature range of the device.
- (5) Regulation is measured at constant junction temperature, using pulse testing with a low duty cycle. Changes in output due to heating effects can be computed by multiplying the internal dissipation by the thermal resistance.

**Electrical Characteristics: LM35, LM35C, LM35D (continued)**

Unless otherwise noted, these specifications apply:  $-55^{\circ}\text{C} \leq T_J \leq 150^{\circ}\text{C}$  for the LM35 and LM35A;  $-40^{\circ}\text{C} \leq T_J \leq 110^{\circ}\text{C}$  for the LM35C and LM35CA; and  $0^{\circ}\text{C} \leq T_J \leq 100^{\circ}\text{C}$  for the LM35D.  $V_S = 5\text{ Vdc}$  and  $I_{\text{LOAD}} = 50\ \mu\text{A}$ , in the circuit of [Full-Range Centigrade Temperature Sensor](#). These specifications also apply from  $2^{\circ}\text{C}$  to  $T_{\text{MAX}}$  in the circuit of [Figure 14](#).

PARAMETER	TEST CONDITIONS	LM35			LM35C, LM35D			UNIT
		MIN	TYP	MAX	MIN	TYP	MAX	
Line regulation <sup>(5)</sup>	$T_A = 25^{\circ}\text{C}$		$\pm 0.01$		$\pm 0.01$		mV/V	
		Tested Limit <sup>(2)</sup>		$\pm 0.1$				
		Design Limit <sup>(3)</sup>				$\pm 0.1$		
	$4\text{ V} \leq V_S \leq 30\text{ V}, -40^{\circ}\text{C} \leq T_J \leq 125^{\circ}\text{C}$		$\pm 0.02$		$\pm 0.02$			
		Tested Limit <sup>(2)</sup>						
		Design Limit <sup>(3)</sup>			$\pm 0.2$			$\pm 0.2$
Quiescent current <sup>(6)</sup>	$V_S = 5\text{ V}, 25^{\circ}\text{C}$		56		56		$\mu\text{A}$	
		Tested Limit <sup>(2)</sup>		80		80		
		Design Limit <sup>(3)</sup>						
	$V_S = 5\text{ V}, -40^{\circ}\text{C} \leq T_J \leq 125^{\circ}\text{C}$			105		91		
		Tested Limit <sup>(2)</sup>						
		Design Limit <sup>(3)</sup>			158			138
	$V_S = 30\text{ V}, 25^{\circ}\text{C}$		56.2		56.2			
		Tested Limit <sup>(2)</sup>			82			82
		Design Limit <sup>(3)</sup>						
	$V_S = 30\text{ V}, -40^{\circ}\text{C} \leq T_J \leq 125^{\circ}\text{C}$			105.5		91.5		
		Tested Limit <sup>(2)</sup>						
		Design Limit <sup>(3)</sup>			161			141
Change of quiescent current <sup>(5)</sup>	$4\text{ V} \leq V_S \leq 30\text{ V}, 25^{\circ}\text{C}$		0.2		0.2		$\mu\text{A}$	
		Tested Limit <sup>(2)</sup>				2		
		Design Limit <sup>(3)</sup>			2			
	$4\text{ V} \leq V_S \leq 30\text{ V}, -40^{\circ}\text{C} \leq T_J \leq 125^{\circ}\text{C}$			0.5		0.5		
		Tested Limit <sup>(2)</sup>						
		Design Limit <sup>(3)</sup>			3			3
Temperature coefficient of quiescent current	$-40^{\circ}\text{C} \leq T_J \leq 125^{\circ}\text{C}$		0.39		0.39		$\mu\text{A}/^{\circ}\text{C}$	
		Tested Limit <sup>(2)</sup>						
		Design Limit <sup>(3)</sup>			0.7			0.7
Minimum temperature for rate accuracy	In circuit of <a href="#">Figure 14</a> , $I_L = 0$		1.5		1.5		$^{\circ}\text{C}$	
		Tested Limit <sup>(2)</sup>						
		Design Limit <sup>(3)</sup>			2			2
Long term stability	$T_J = T_{\text{MAX}}$ , for 1000 hours		$\pm 0.08$		$\pm 0.08$		$^{\circ}\text{C}$	

(6) Quiescent current is defined in the circuit of [Figure 14](#).

### 6.9 Typical Characteristics

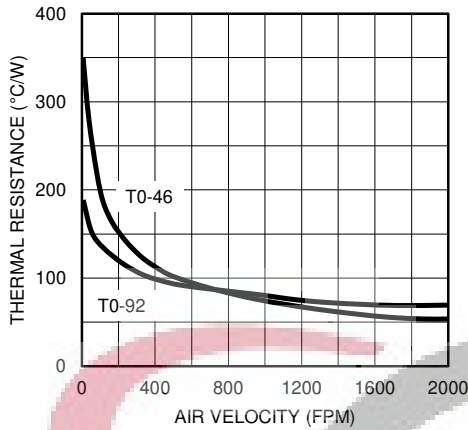

Figure 1. Thermal Resistance Junction To Air

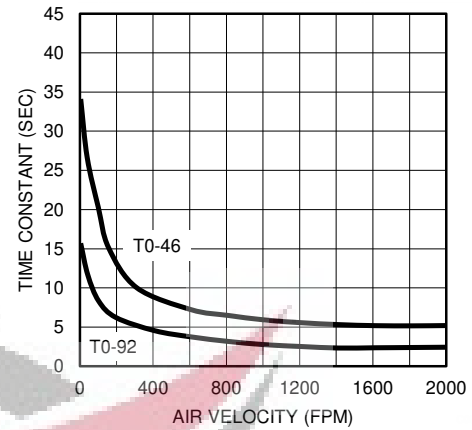

Figure 2. Thermal Time Constant

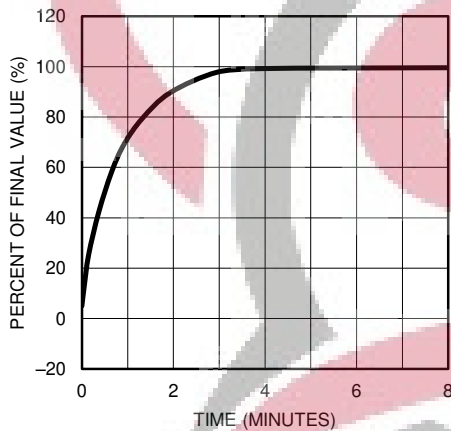

Figure 3. Thermal Response in Still Air

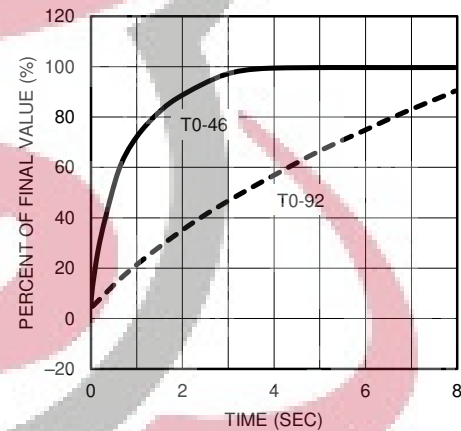

Figure 4. Thermal Response in Stirred Oil Bath

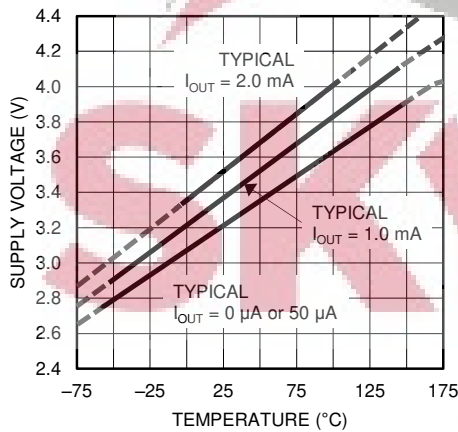

Figure 5. Minimum Supply Voltage vs Temperature

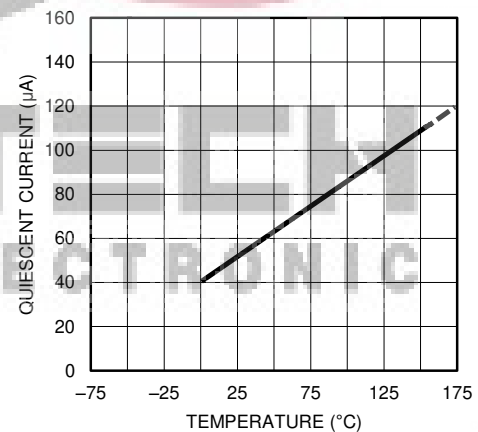

Figure 6. Quiescent Current vs Temperature (in Circuit of Figure 14)

Typical Characteristics (continued)

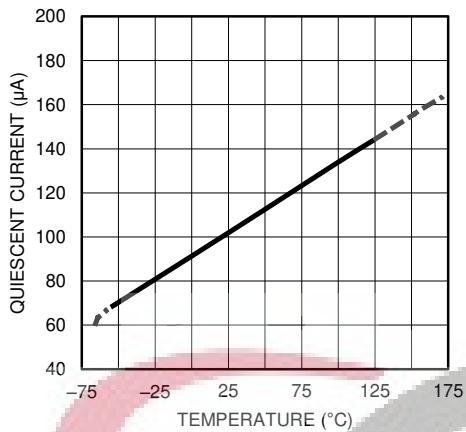

Figure 7. Quiescent Current vs Temperature (in Circuit of Full-Range Centigrade Temperature Sensor)

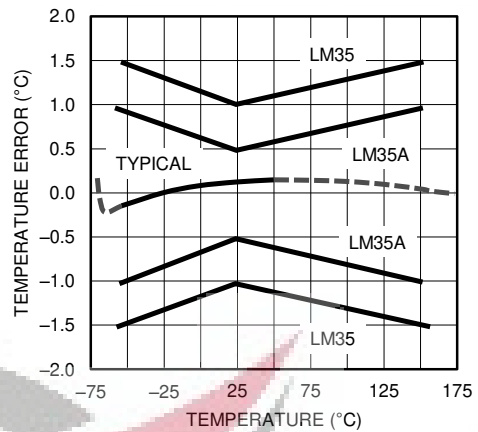

Figure 8. Accuracy vs Temperature (Ensured)

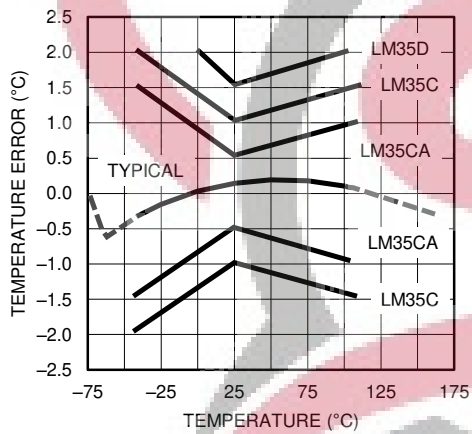

Figure 9. Accuracy vs Temperature (Ensured)

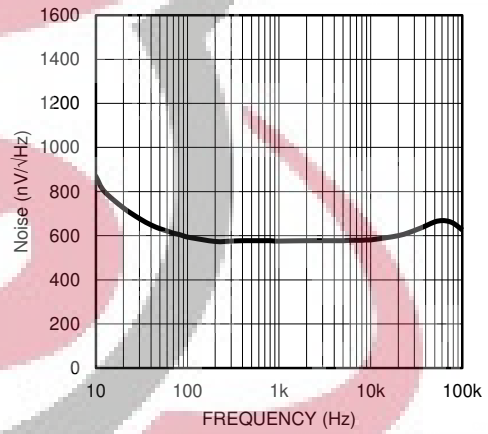

Figure 10. Noise Voltage

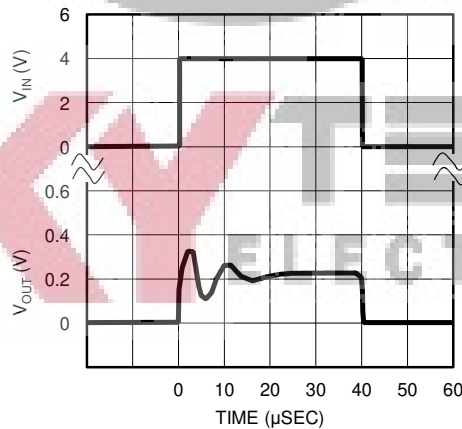

Figure 11. Start-Up Response

## 7 Detailed Description

### 7.1 Overview

The LM35-series devices are precision integrated-circuit temperature sensors, with an output voltage linearly proportional to the Centigrade temperature. The LM35 device has an advantage over linear temperature sensors calibrated in Kelvin, as the user is not required to subtract a large constant voltage from the output to obtain convenient Centigrade scaling. The LM35 device does not require any external calibration or trimming to provide typical accuracies of  $\pm 1/4^\circ\text{C}$  at room temperature and  $\pm 3/4^\circ\text{C}$  over a full  $-55^\circ\text{C}$  to  $150^\circ\text{C}$  temperature range. Lower cost is assured by trimming and calibration at the wafer level. The low output impedance, linear output, and precise inherent calibration of the LM35 device makes interfacing to readout or control circuitry especially easy. The device is used with single power supplies, or with plus and minus supplies. As the LM35 device draws only  $60\ \mu\text{A}$  from the supply, it has very low self-heating of less than  $0.1^\circ\text{C}$  in still air. The LM35 device is rated to operate over a  $-55^\circ\text{C}$  to  $150^\circ\text{C}$  temperature range, while the LM35C device is rated for a  $-40^\circ\text{C}$  to  $110^\circ\text{C}$  range ( $-10^\circ$  with improved accuracy). The temperature-sensing element is comprised of a delta-V BE architecture.

The temperature-sensing element is then buffered by an amplifier and provided to the VOUT pin. The amplifier has a simple class A output stage with typical  $0.5\text{-}\Omega$  output impedance as shown in the *Functional Block Diagram*. Therefore the LM35 can only source current and its sinking capability is limited to  $1\ \mu\text{A}$ .

### 7.2 Functional Block Diagram

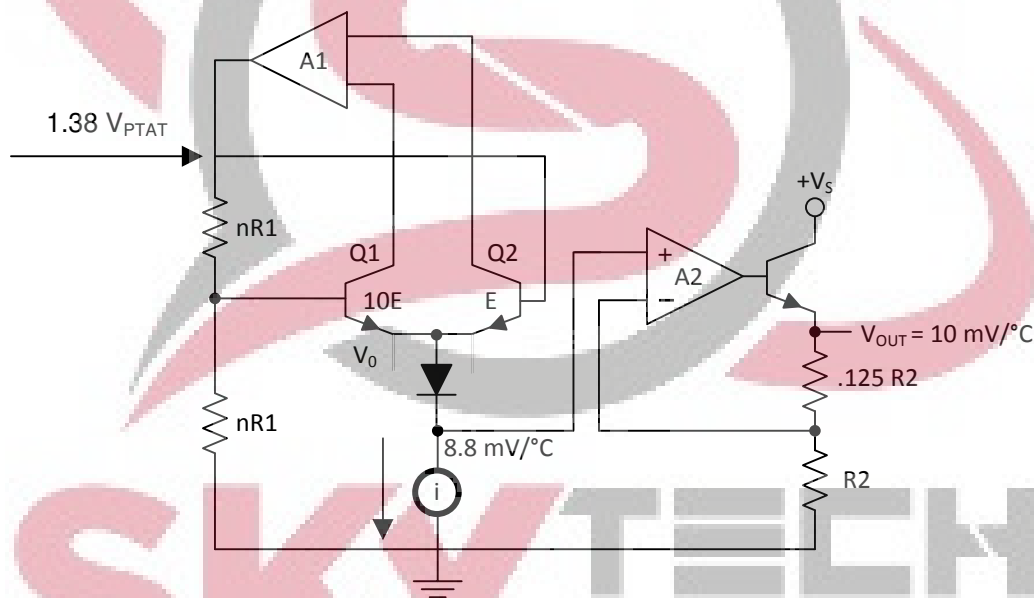

### 7.3 Feature Description

#### 7.3.1 LM35 Transfer Function

The accuracy specifications of the LM35 are given with respect to a simple linear transfer function:

$$V_{\text{OUT}} = 10\ \text{mV}/^\circ\text{C} \times T$$

where

- $V_{\text{OUT}}$  is the LM35 output voltage
- $T$  is the temperature in  $^\circ\text{C}$

(1)

### 7.4 Device Functional Modes

The only functional mode of the LM35 is that it has an analog output directly proportional to temperature.



## 8.2 Typical Application

### 8.2.1 Basic Centigrade Temperature Sensor

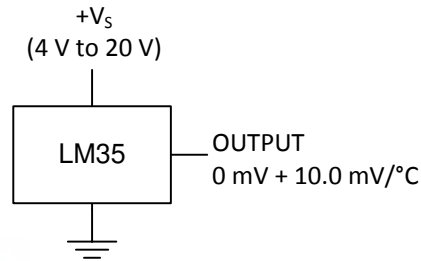

Figure 14. Basic Centigrade Temperature Sensor (2 °C to 150 °C)

#### 8.2.1.1 Design Requirements

Table 1. Design Parameters

PARAMETER	VALUE
Accuracy at 25°C	±0.5°C
Accuracy from –55 °C to 150°C	±1°C
Temperature Slope	10 mV/°C

#### 8.2.1.2 Detailed Design Procedure

Because the LM35 device is a simple temperature sensor that provides an analog output, design requirements related to layout are more important than electrical requirements. For a detailed description, refer to the [Layout](#).

#### 8.2.1.3 Application Curve

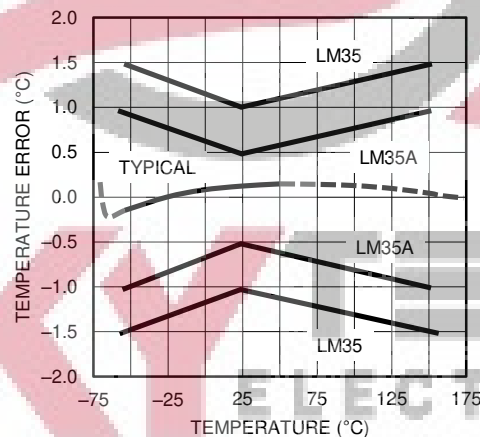

Figure 15. Accuracy vs Temperature (Ensured)

8.3 System Examples

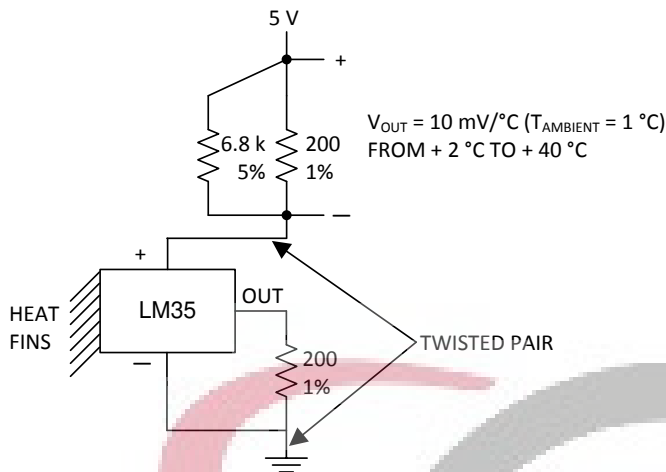

Figure 16. Two-Wire Remote Temperature Sensor (Grounded Sensor)

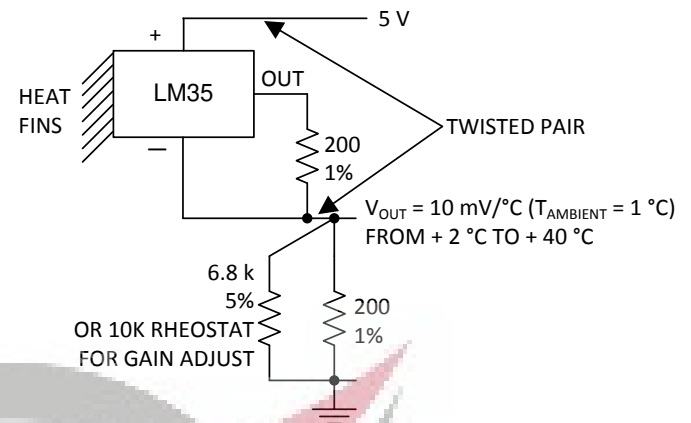

Figure 17. Two-Wire Remote Temperature Sensor (Output Referred to Ground)

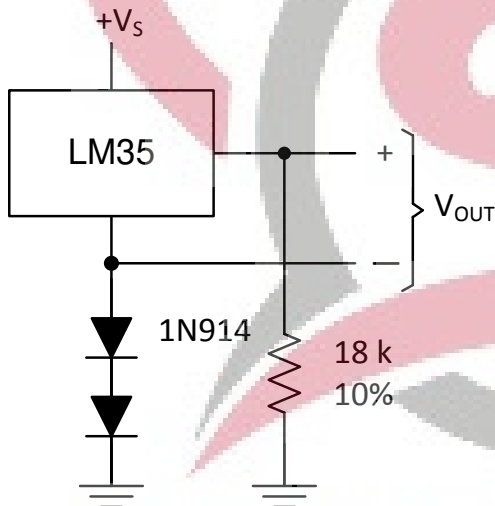

Figure 18. Temperature Sensor, Single Supply (-55° to +150°C)

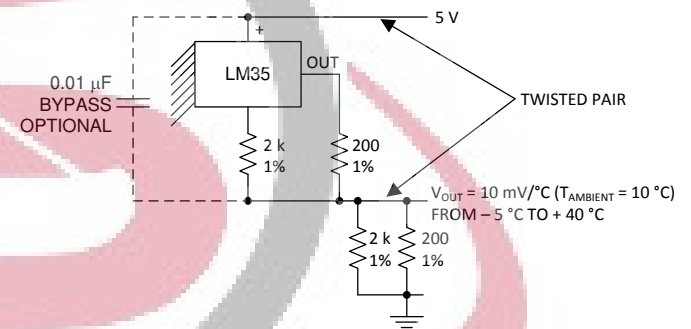
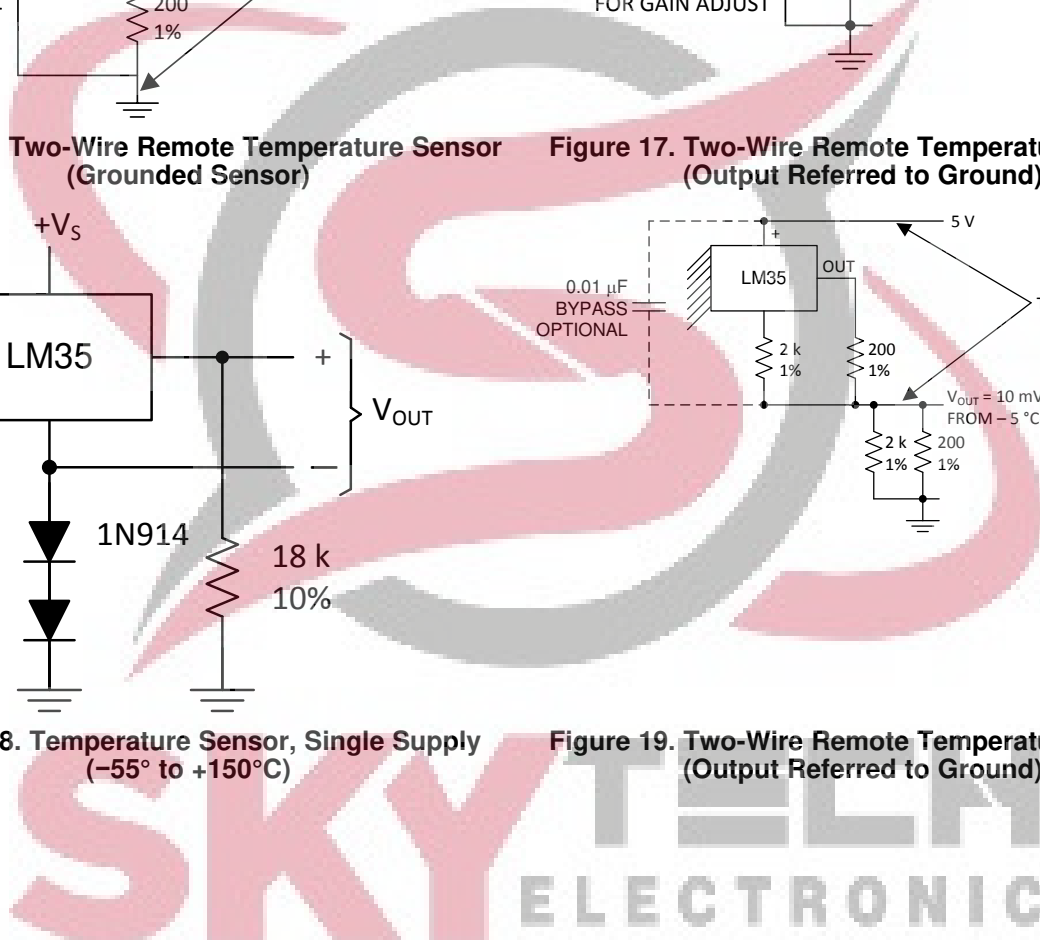

Figure 19. Two-Wire Remote Temperature Sensor (Output Referred to Ground)



System Examples (continued)

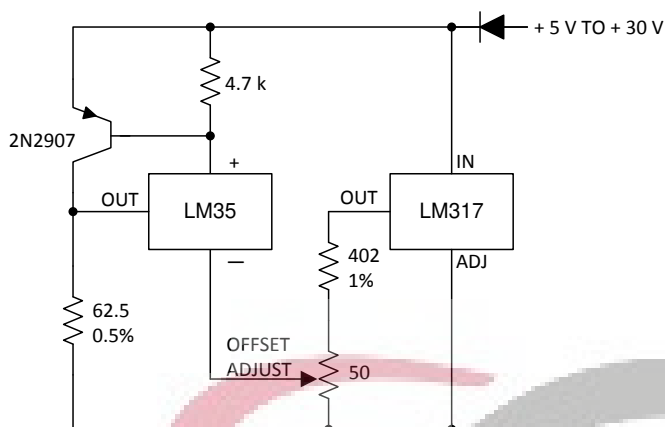

Figure 20. 4-To-20 mA Current Source (0°C to 100°C)

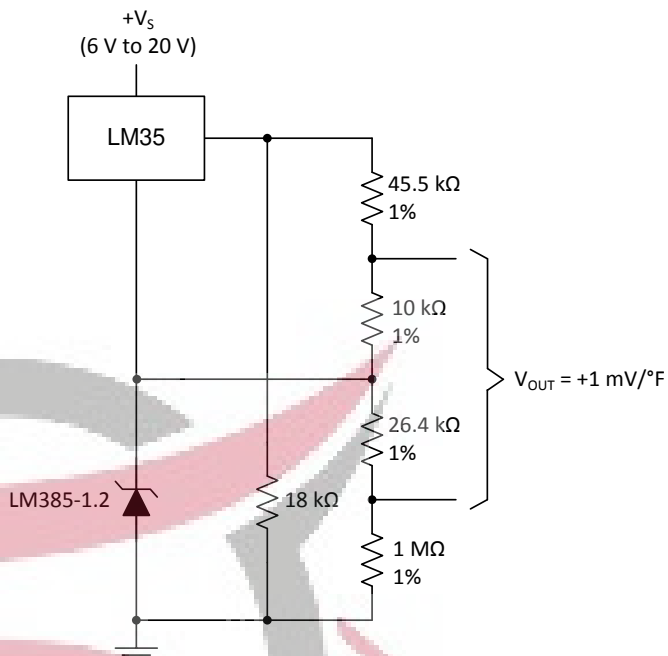

Figure 21. Fahrenheit Thermometer

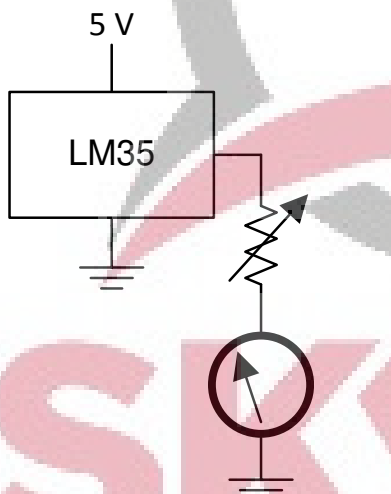

Figure 22. Centigrade Thermometer (Analog Meter)

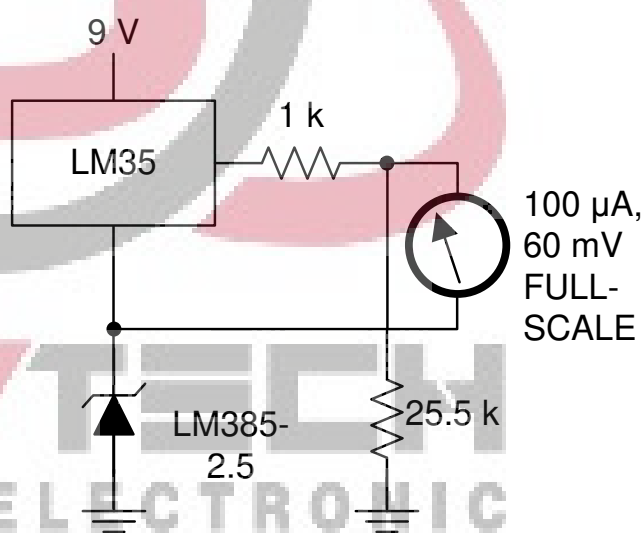

Figure 23. Fahrenheit Thermometer, Expanded Scale Thermometer (50°F to 80°F, for Example Shown)



## 9 Power Supply Recommendations

The LM35 device has a very wide 4-V to 30-V power supply voltage range, which makes it ideal for many applications. In noisy environments, TI recommends adding a 0.1  $\mu\text{F}$  from V+ to GND to bypass the power supply voltage. Larger capacitances may be required and are dependent on the power-supply noise.

## 10 Layout

### 10.1 Layout Guidelines

The LM35 is easily applied in the same way as other integrated-circuit temperature sensors. Glue or cement the device to a surface and the temperature should be within about 0.01°C of the surface temperature.

The 0.01°C proximity presumes that the ambient air temperature is almost the same as the surface temperature. If the air temperature were much higher or lower than the surface temperature, the actual temperature of the LM35 die would be at an intermediate temperature between the surface temperature and the air temperature; this is especially true for the TO-92 plastic package. The copper leads in the TO-92 package are the principal thermal path to carry heat into the device, so its temperature might be closer to the air temperature than to the surface temperature.

Ensure that the wiring leaving the LM35 device is held at the same temperature as the surface of interest to minimize the temperature problem. The easiest fix is to cover up these wires with a bead of epoxy. The epoxy bead will ensure that the leads and wires are all at the same temperature as the surface, and that the temperature of the LM35 die is not affected by the air temperature.

The TO-46 metal package can also be soldered to a metal surface or pipe without damage. Of course, in that case the V- terminal of the circuit will be grounded to that metal. Alternatively, mount the LM35 inside a sealed-end metal tube, and then dip into a bath or screw into a threaded hole in a tank. As with any IC, the LM35 device and accompanying wiring and circuits must be kept insulated and dry, to avoid leakage and corrosion. This is especially true if the circuit may operate at cold temperatures where condensation can occur. Printed-circuit coatings and varnishes such as a conformal coating and epoxy paints or dips are often used to insure that moisture cannot corrode the LM35 device or its connections.

These devices are sometimes soldered to a small light-weight heat fin to decrease the thermal time constant and speed up the response in slowly-moving air. On the other hand, a small thermal mass may be added to the sensor, to give the steadiest reading despite small deviations in the air temperature.

**Table 2. Temperature Rise of LM35 Due To Self-heating (Thermal Resistance,  $R_{\theta JA}$ )**

	TO, no heat sink	TO <sup>(1)</sup> , small heat fin	TO-92, no heat sink	TO-92 <sup>(2)</sup> , small heat fin	SOIC-8, no heat sink	SOIC-8 <sup>(2)</sup> , small heat fin	TO-220, no heat sink
Still air	400°C/W	100°C/W	180°C/W	140°C/W	220°C/W	110°C/W	90°C/W
Moving air	100°C/W	40°C/W	90°C/W	70°C/W	105°C/W	90°C/W	26°C/W
Still oil	100°C/W	40°C/W	90°C/W	70°C/W	—	—	—
Stirred oil	50°C/W	30°C/W	45°C/W	40°C/W	—	—	—
(Clamped to metal, Infinite heat sink)	(24°C/W)		—	—	(55°C/W)		—

(1) Wakefield type 201, or 1-in disc of 0.02-in sheet brass, soldered to case, or similar.

(2) TO-92 and SOIC-8 packages glued and leads soldered to 1-in square of 1/16-in printed circuit board with 2-oz foil or similar.



## 11 Device and Documentation Support

### 11.1 Receiving Notification of Documentation Updates

To receive notification of documentation updates, navigate to the device product folder on ti.com. In the upper right corner, click on *Alert me* to register and receive a weekly digest of any product information that has changed. For change details, review the revision history included in any revised document

### 11.2 Community Resources

The following links connect to TI community resources. Linked contents are provided "AS IS" by the respective contributors. They do not constitute TI specifications and do not necessarily reflect TI's views; see TI's [Terms of Use](#).

**TI E2E™ Online Community** *TI's Engineer-to-Engineer (E2E) Community*. Created to foster collaboration among engineers. At e2e.ti.com, you can ask questions, share knowledge, explore ideas and help solve problems with fellow engineers.

**Design Support** *TI's Design Support* Quickly find helpful E2E forums along with design support tools and contact information for technical support.

### 11.3 Trademarks

E2E is a trademark of Texas Instruments.  
All other trademarks are the property of their respective owners.

### 11.4 Electrostatic Discharge Caution



These devices have limited built-in ESD protection. The leads should be shorted together or the device placed in conductive foam during storage or handling to prevent electrostatic damage to the MOS gates.

### 11.5 Glossary

[SLYZ022](#) — *TI Glossary*.

This glossary lists and explains terms, acronyms, and definitions.

## 12 Mechanical, Packaging, and Orderable Information

The following pages include mechanical, packaging, and orderable information. This information is the most current data available for the designated devices. This data is subject to change without notice and revision of this document. For browser-based versions of this data sheet, refer to the left-hand navigation.

SKYTECH  
ELECTRONIC

**PACKAGING INFORMATION**

Orderable Device	Status (1)	Package Type	Package Drawing	Pins	Package Qty	Eco Plan (2)	Lead/Ball Finish (6)	MSL Peak Temp (3)	Op Temp (°C)	Device Marking (4/5)	Samples
LM35AH	ACTIVE	TO	NDV	3	500	TBD	Call TI	Call TI	-55 to 150	( LM35AH, LM35AH)	<a href="#">Samples</a>
LM35AH/NOPB	ACTIVE	TO	NDV	3	500	Green (RoHS & no Sb/Br)	Call TI	Level-1-NA-UNLIM	-55 to 150	( LM35AH, LM35AH)	<a href="#">Samples</a>
LM35CAH	ACTIVE	TO	NDV	3	500	TBD	Call TI	Call TI	-40 to 110	( LM35CAH, LM35CAH )	<a href="#">Samples</a>
LM35CAH/NOPB	ACTIVE	TO	NDV	3	500	Green (RoHS & no Sb/Br)	Call TI	Level-1-NA-UNLIM	-40 to 110	( LM35CAH, LM35CAH )	<a href="#">Samples</a>
LM35CAZ/LFT4	ACTIVE	TO-92	LP	3	2000	Green (RoHS & no Sb/Br)	SN	N / A for Pkg Type		LM35 CAZ	<a href="#">Samples</a>
LM35CAZ/NOPB	ACTIVE	TO-92	LP	3	1800	Green (RoHS & no Sb/Br)	SN	N / A for Pkg Type	-40 to 110	LM35 CAZ	<a href="#">Samples</a>
LM35CH	ACTIVE	TO	NDV	3	500	TBD	Call TI	Call TI	-40 to 110	( LM35CH, LM35CH)	<a href="#">Samples</a>
LM35CH/NOPB	ACTIVE	TO	NDV	3	500	Green (RoHS & no Sb/Br)	Call TI	Level-1-NA-UNLIM	-40 to 110	( LM35CH, LM35CH)	<a href="#">Samples</a>
LM35CZ/LFT1	ACTIVE	TO-92	LP	3	2000	Green (RoHS & no Sb/Br)	SN	N / A for Pkg Type		LM35 CZ	<a href="#">Samples</a>
LM35CZ/NOPB	ACTIVE	TO-92	LP	3	1800	Green (RoHS & no Sb/Br)	SN	N / A for Pkg Type	-40 to 110	LM35 CZ	<a href="#">Samples</a>
LM35DH	ACTIVE	TO	NDV	3	1000	TBD	Call TI	Call TI	0 to 70	( LM35DH, LM35DH)	<a href="#">Samples</a>
LM35DH/NOPB	ACTIVE	TO	NDV	3	1000	Green (RoHS & no Sb/Br)	Call TI	Level-1-NA-UNLIM	0 to 70	( LM35DH, LM35DH)	<a href="#">Samples</a>
LM35DM	NRND	SOIC	D	8	95	TBD	Call TI	Call TI	0 to 100	LM35D M	
LM35DM/NOPB	ACTIVE	SOIC	D	8	95	Green (RoHS & no Sb/Br)	SN	Level-1-260C-UNLIM	0 to 100	LM35D M	<a href="#">Samples</a>
LM35DMX	NRND	SOIC	D	8	2500	TBD	Call TI	Call TI	0 to 100	LM35D M	
LM35DMX/NOPB	ACTIVE	SOIC	D	8	2500	Green (RoHS & no Sb/Br)	SN	Level-1-260C-UNLIM	0 to 100	LM35D M	<a href="#">Samples</a>
LM35DT	NRND	TO-220	NEB	3	45	TBD	Call TI	Call TI	0 to 100	LM35DT	
LM35DT/NOPB	ACTIVE	TO-220	NEB	3	45	Green (RoHS & no Sb/Br)	SN	Level-1-NA-UNLIM	0 to 100	LM35DT	<a href="#">Samples</a>

Orderable Device	Status (1)	Package Type	Package Drawing	Pins	Package Qty	Eco Plan (2)	Lead/Ball Finish (6)	MSL Peak Temp (3)	Op Temp (°C)	Device Marking (4/5)	Samples
LM35DZ/LFT1	ACTIVE	TO-92	LP	3	2000	Green (RoHS & no Sb/Br)	SN	N / A for Pkg Type		LM35 DZ	<a href="#">Samples</a>
LM35DZ/LFT4	ACTIVE	TO-92	LP	3	2000	Green (RoHS & no Sb/Br)	SN	N / A for Pkg Type		LM35 DZ	<a href="#">Samples</a>
LM35DZ/NOPB	ACTIVE	TO-92	LP	3	1800	Green (RoHS & no Sb/Br)	SN	N / A for Pkg Type	0 to 100	LM35 DZ	<a href="#">Samples</a>
LM35H	ACTIVE	TO	NDV	3	500	TBD	Call TI	Call TI	-55 to 150	( LM35H, LM35H)	<a href="#">Samples</a>
LM35H/NOPB	ACTIVE	TO	NDV	3	500	Green (RoHS & no Sb/Br)	Call TI	Level-1-NA-UNLIM	-55 to 150	( LM35H, LM35H)	<a href="#">Samples</a>

(1) The marketing status values are defined as follows:

**ACTIVE:** Product device recommended for new designs.

**LIFEBUY:** TI has announced that the device will be discontinued, and a lifetime-buy period is in effect.

**NRND:** Not recommended for new designs. Device is in production to support existing customers, but TI does not recommend using this part in a new design.

**PREVIEW:** Device has been announced but is not in production. Samples may or may not be available.

**OBSOLETE:** TI has discontinued the production of the device.

(2) **RoHS:** TI defines "RoHS" to mean semiconductor products that are compliant with the current EU RoHS requirements for all 10 RoHS substances, including the requirement that RoHS substance do not exceed 0.1% by weight in homogeneous materials. Where designed to be soldered at high temperatures, "RoHS" products are suitable for use in specified lead-free processes. TI may reference these types of products as "Pb-Free".

**RoHS Exempt:** TI defines "RoHS Exempt" to mean products that contain lead but are compliant with EU RoHS pursuant to a specific EU RoHS exemption.

**Green:** TI defines "Green" to mean the content of Chlorine (Cl) and Bromine (Br) based flame retardants meet JS709B low halogen requirements of <=1000ppm threshold. Antimony trioxide based flame retardants must also meet the <=1000ppm threshold requirement.

(3) MSL, Peak Temp. - The Moisture Sensitivity Level rating according to the JEDEC industry standard classifications, and peak solder temperature.

(4) There may be additional marking, which relates to the logo, the lot trace code information, or the environmental category on the device.

(5) Multiple Device Markings will be inside parentheses. Only one Device Marking contained in parentheses and separated by a "~" will appear on a device. If a line is indented then it is a continuation of the previous line and the two combined represent the entire Device Marking for that device.

(6) Lead/Ball Finish - Orderable Devices may have multiple material finish options. Finish options are separated by a vertical ruled line. Lead/Ball Finish values may wrap to two lines if the finish value exceeds the maximum column width.

**Important Information and Disclaimer:**The information provided on this page represents TI's knowledge and belief as of the date that it is provided. TI bases its knowledge and belief on information provided by third parties, and makes no representation or warranty as to the accuracy of such information. Efforts are underway to better integrate information from third parties. TI has taken and

---

continues to take reasonable steps to provide representative and accurate information but may not have conducted destructive testing or chemical analysis on incoming materials and chemicals. TI and TI suppliers consider certain information to be proprietary, and thus CAS numbers and other limited information may not be available for release.

In no event shall TI's liability arising out of such information exceed the total purchase price of the TI part(s) at issue in this document sold by TI to Customer on an annual basis.



**TAPE AND REEL INFORMATION**

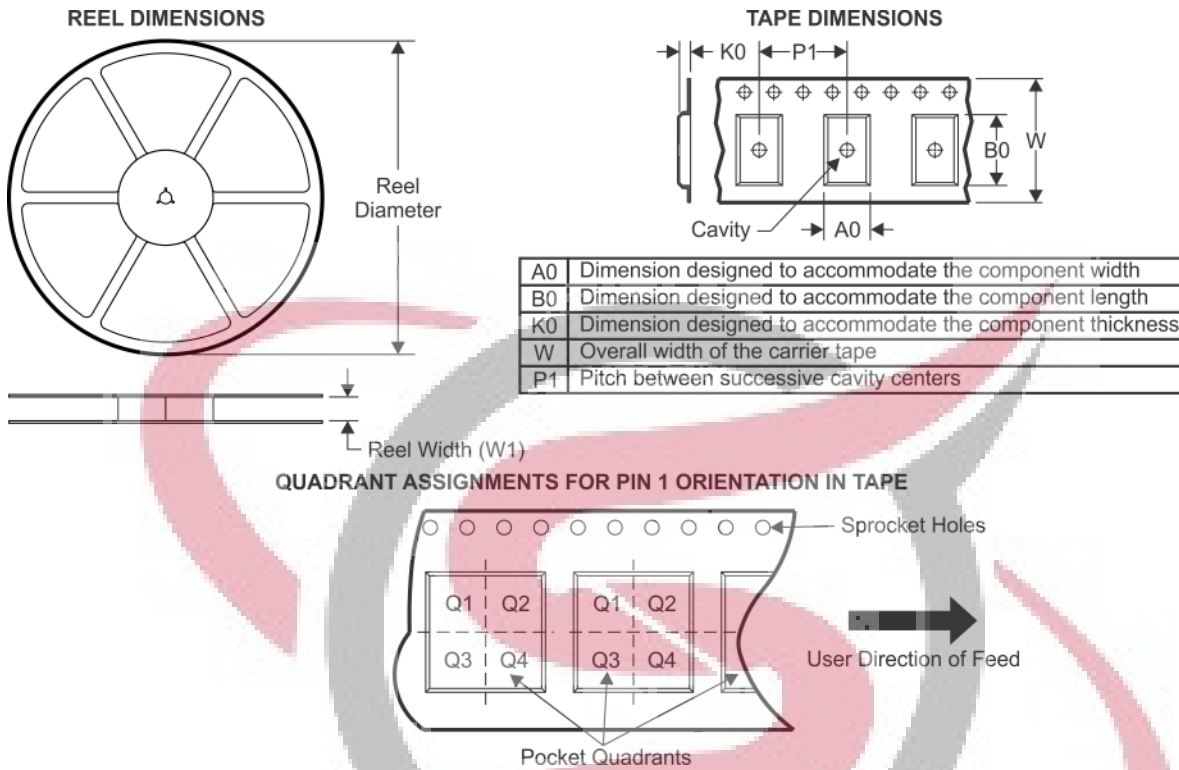

\*All dimensions are nominal

Device	Package Type	Package Drawing	Pins	SPQ	Reel Diameter (mm)	Reel Width W1 (mm)	A0 (mm)	B0 (mm)	K0 (mm)	P1 (mm)	W (mm)	Pin1 Quadrant
LM35DMX	SOIC	D	8	2500	330.0	12.4	6.5	5.4	2.0	8.0	12.0	Q1
LM35DMX/NOPB	SOIC	D	8	2500	330.0	12.4	6.5	5.4	2.0	8.0	12.0	Q1



TAPE AND REEL BOX DIMENSIONS

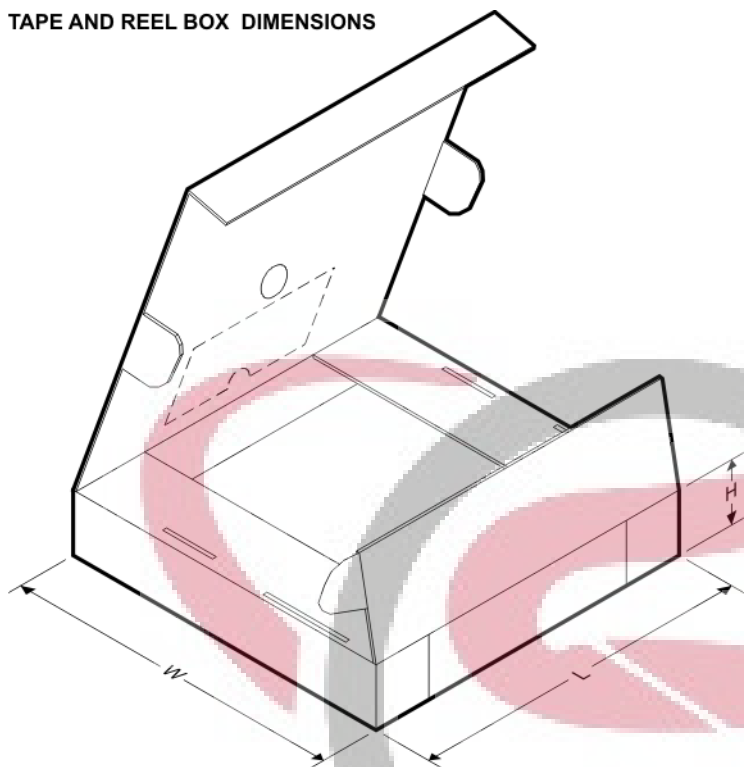

\*All dimensions are nominal

Device	Package Type	Package Drawing	Pins	SPQ	Length (mm)	Width (mm)	Height (mm)
LM35DMX	SOIC	D	8	2500	367.0	367.0	35.0
LM35DMX/NOPB	SOIC	D	8	2500	367.0	367.0	35.0

**SKY**TECH  
ELECTRONIC

NDV0003H



**PACKAGE OUTLINE**  
**TO-CAN - 2.67 mm max height**

TO-46

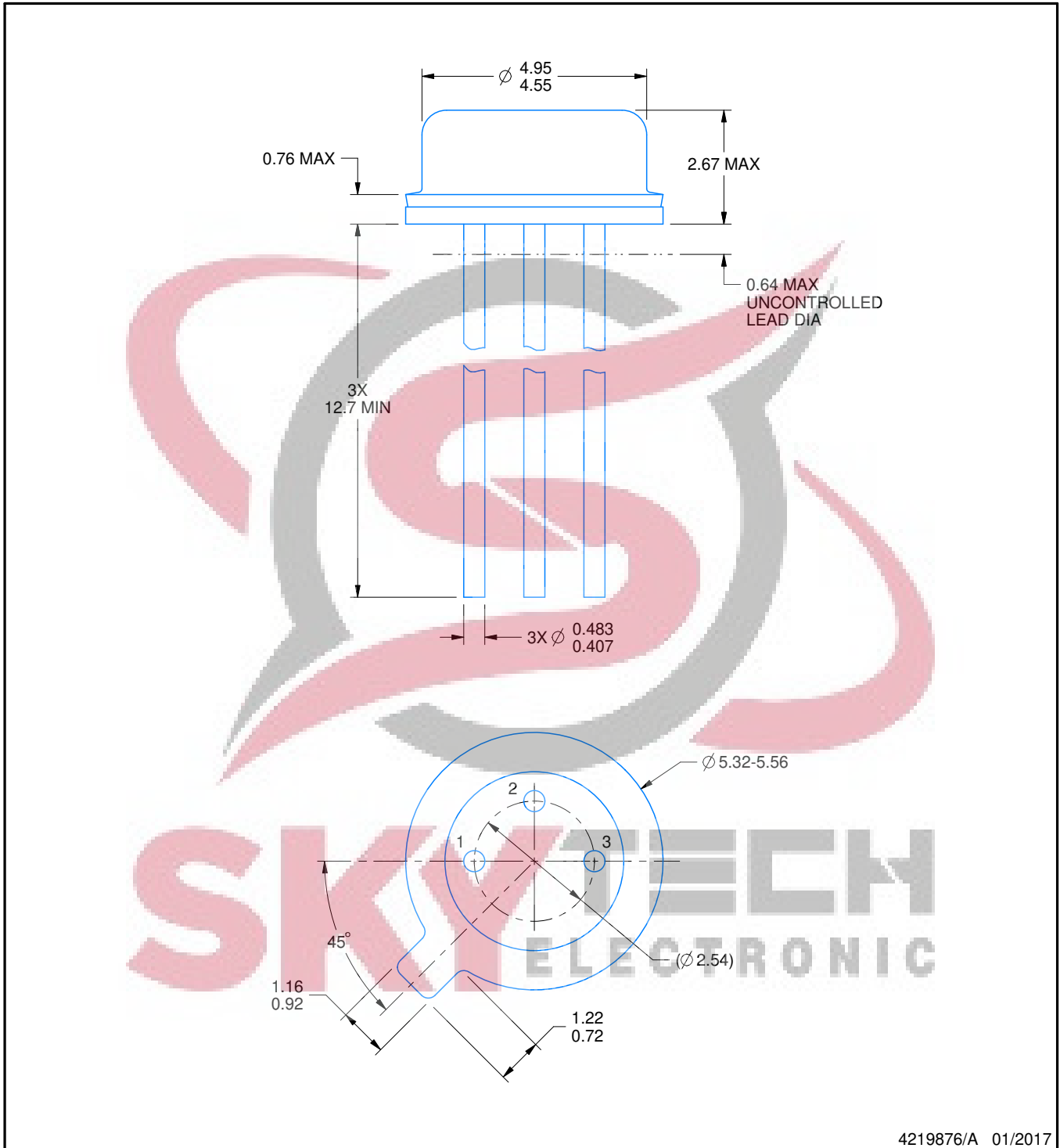

4219876/A 01/2017

NOTES:

1. All linear dimensions are in millimeters. Any dimensions in parenthesis are for reference only. Dimensioning and tolerancing per ASME Y14.5M.
2. This drawing is subject to change without notice.
3. Reference JEDEC registration TO-46.

# EXAMPLE BOARD LAYOUT

NDV0003H

TO-CAN - 2.67 mm max height

TO-46

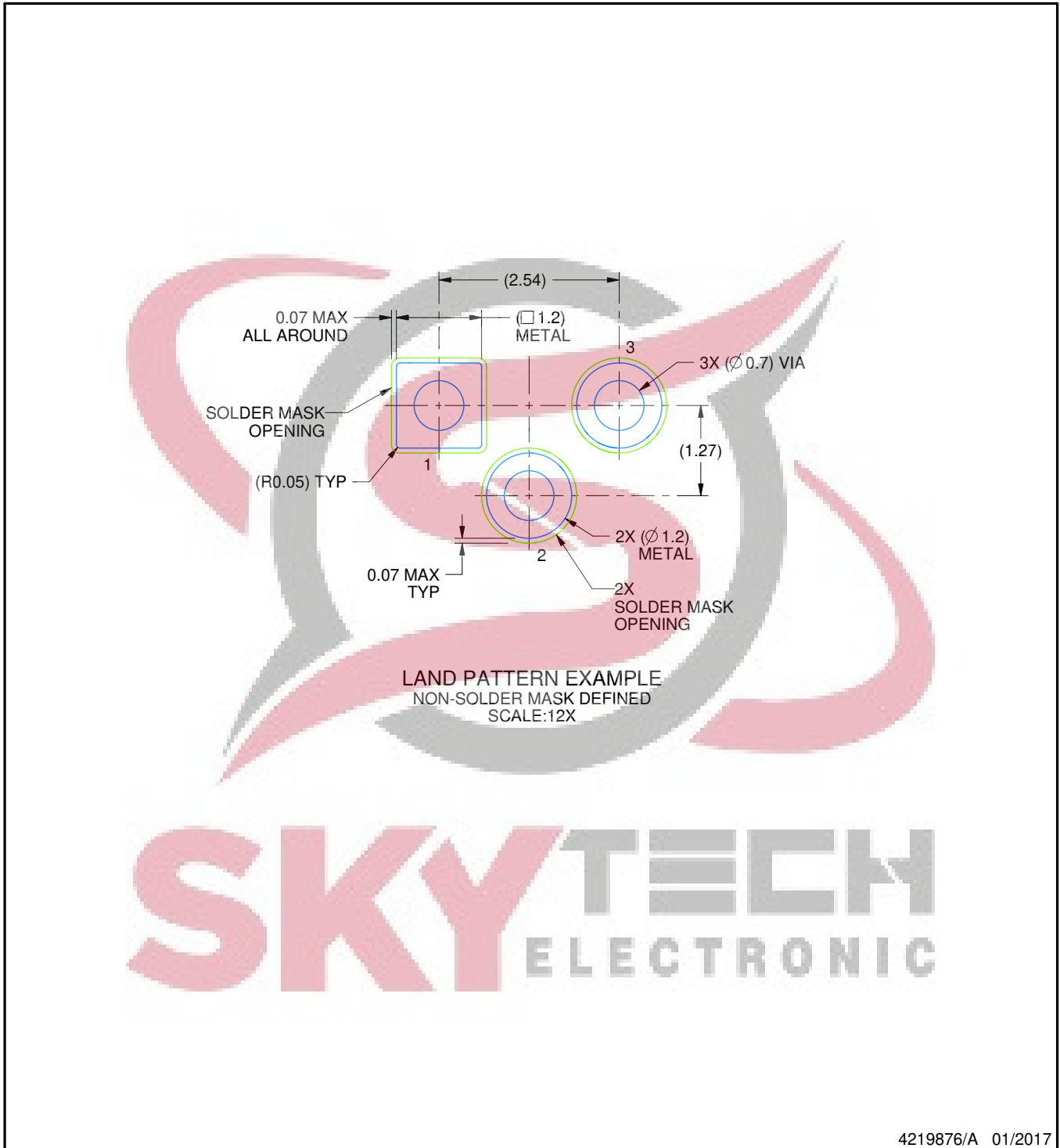

D0008A

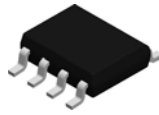

# PACKAGE OUTLINE

SOIC - 1.75 mm max height

SMALL OUTLINE INTEGRATED CIRCUIT

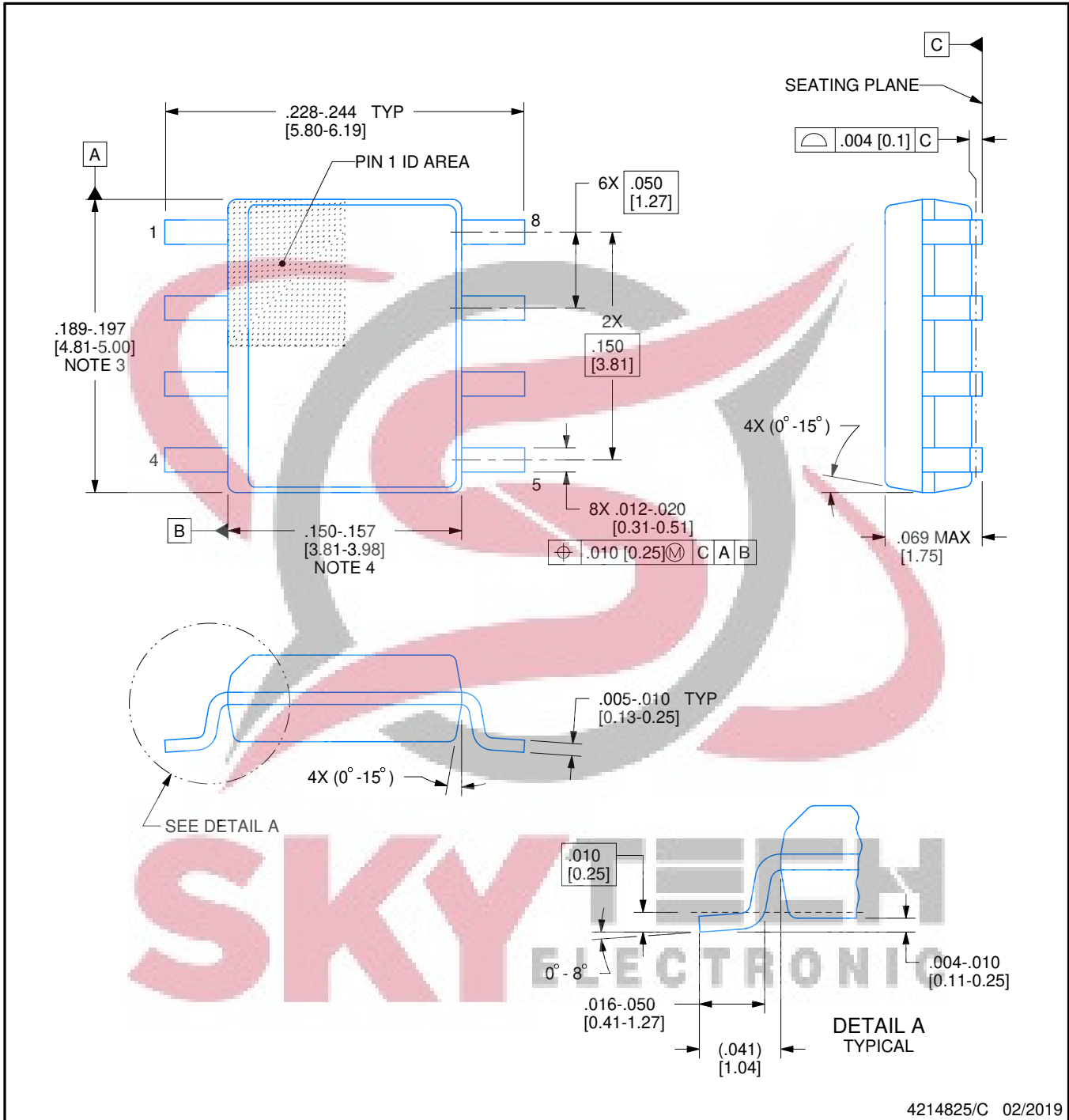

4214825/C 02/2019

NOTES:

1. Linear dimensions are in inches [millimeters]. Dimensions in parenthesis are for reference only. Controlling dimensions are in inches. Dimensioning and tolerancing per ASME Y14.5M.
2. This drawing is subject to change without notice.
3. This dimension does not include mold flash, protrusions, or gate burrs. Mold flash, protrusions, or gate burrs shall not exceed .006 [0.15] per side.
4. This dimension does not include interlead flash.
5. Reference JEDEC registration MS-012, variation AA.



# EXAMPLE BOARD LAYOUT

D0008A

SOIC - 1.75 mm max height

SMALL OUTLINE INTEGRATED CIRCUIT

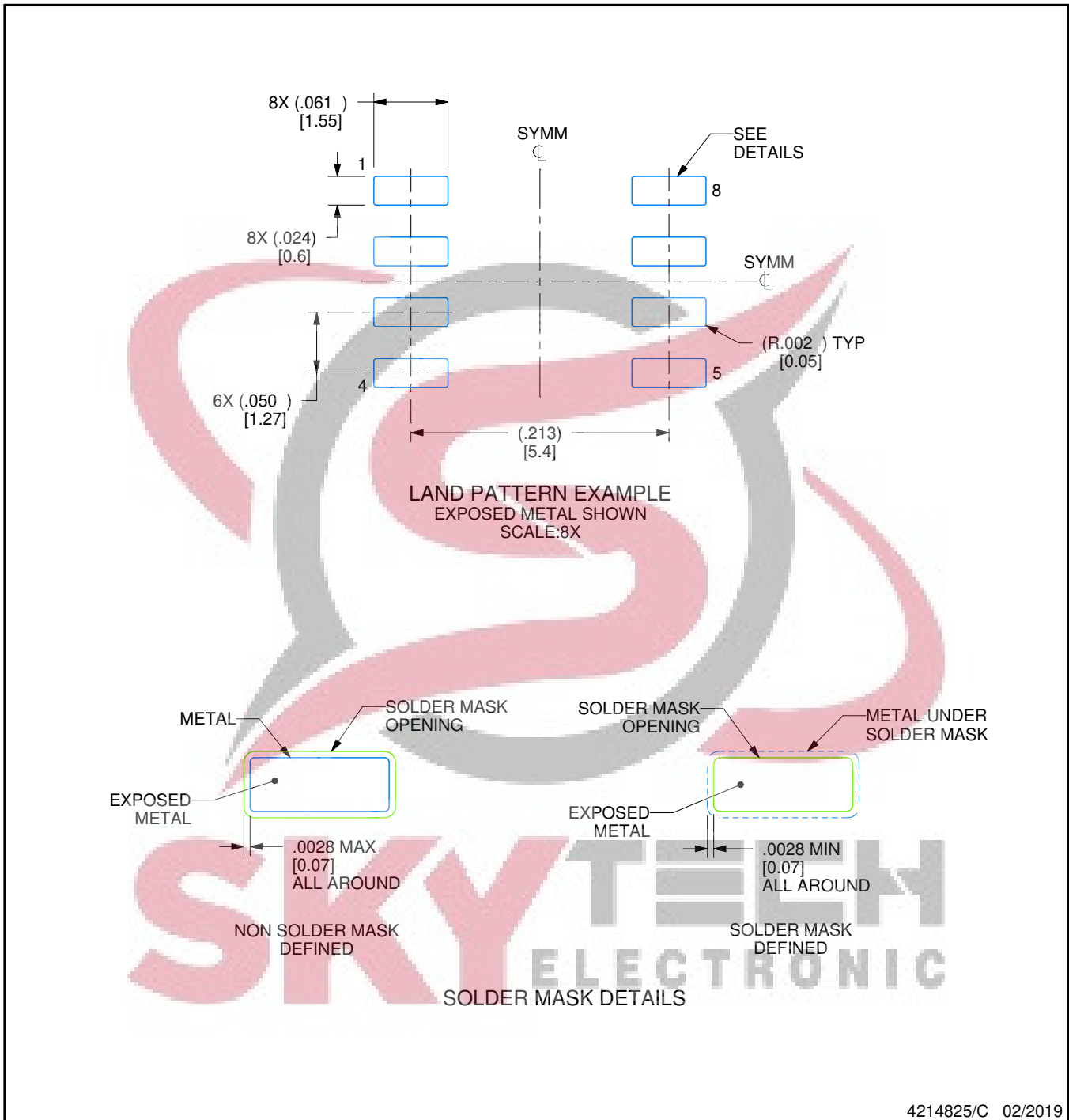

NOTES: (continued)

6. Publication IPC-7351 may have alternate designs.

7. Solder mask tolerances between and around signal pads can vary based on board fabrication site.

# EXAMPLE STENCIL DESIGN

D0008A

SOIC - 1.75 mm max height

SMALL OUTLINE INTEGRATED CIRCUIT

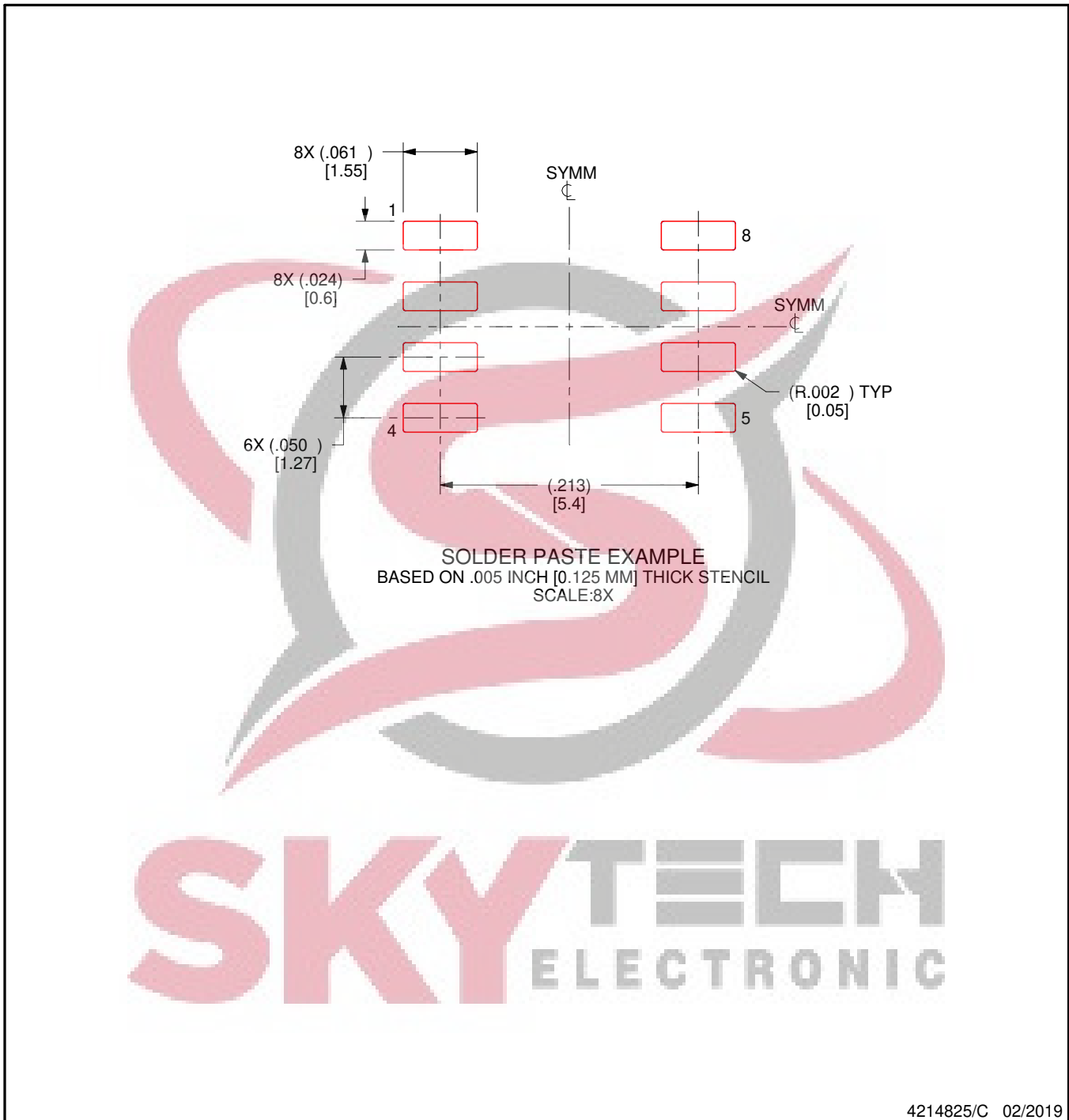

NOTES: (continued)

8. Laser cutting apertures with trapezoidal walls and rounded corners may offer better paste release. IPC-7525 may have alternate design recommendations.
9. Board assembly site may have different recommendations for stencil design.

# NEB0003F

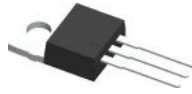

# PACKAGE OUTLINE

TO-220 - 19.65 mm max height

TRANSISTOR OUTLINE

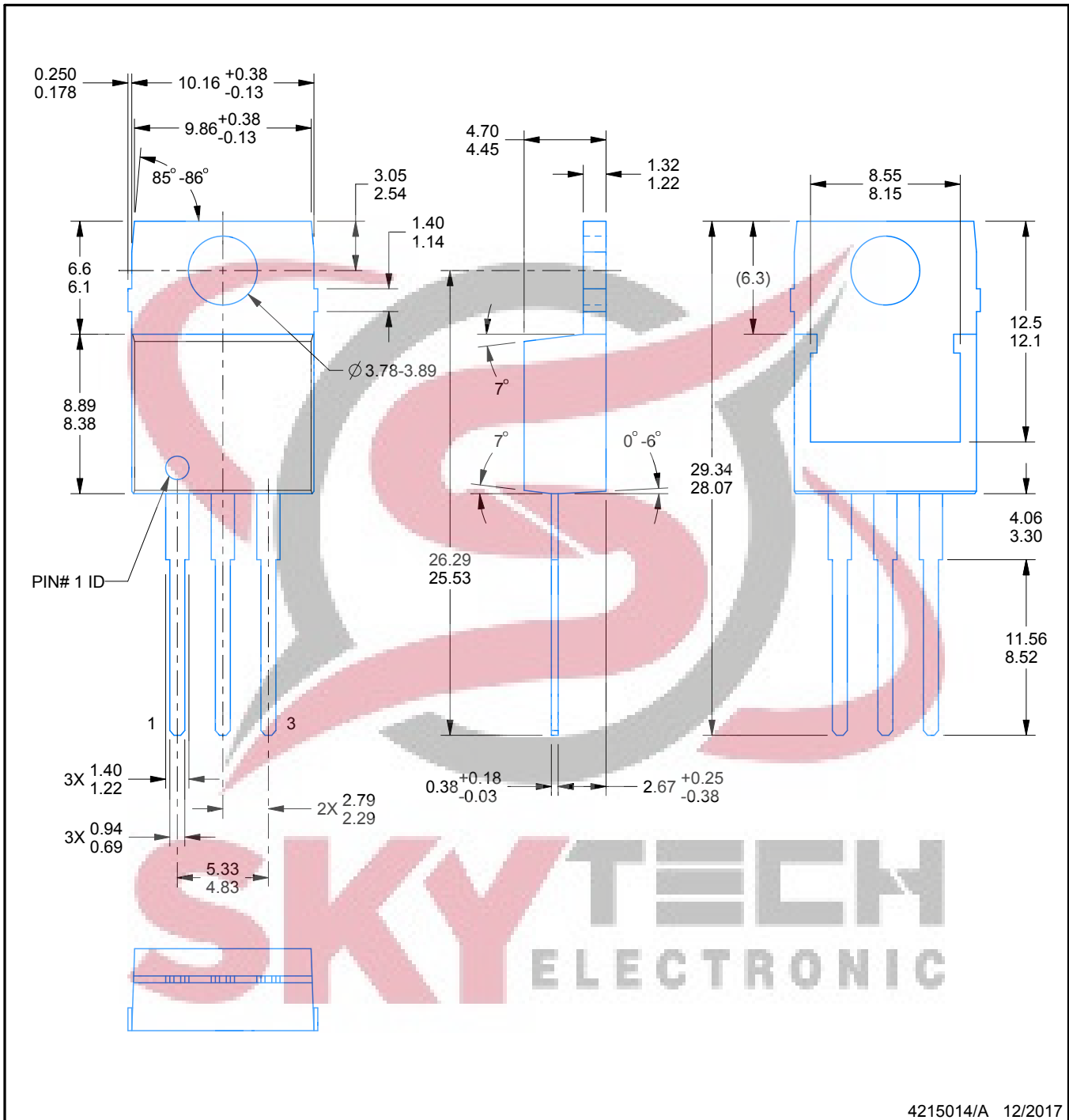

## NOTES:

1. All controlling linear dimensions are in inches. Dimensions in brackets are in millimeters. Any dimension in brackets or parenthesis are for reference only. Dimensioning and tolerancing per ASME Y14.5M.
2. This drawing is subject to change without notice.
3. Reference JEDEC registration TO-220.

# EXAMPLE BOARD LAYOUT

NEB0003F

TO-220 - 19.65 mm max height

TRANSISTOR OUTLINE

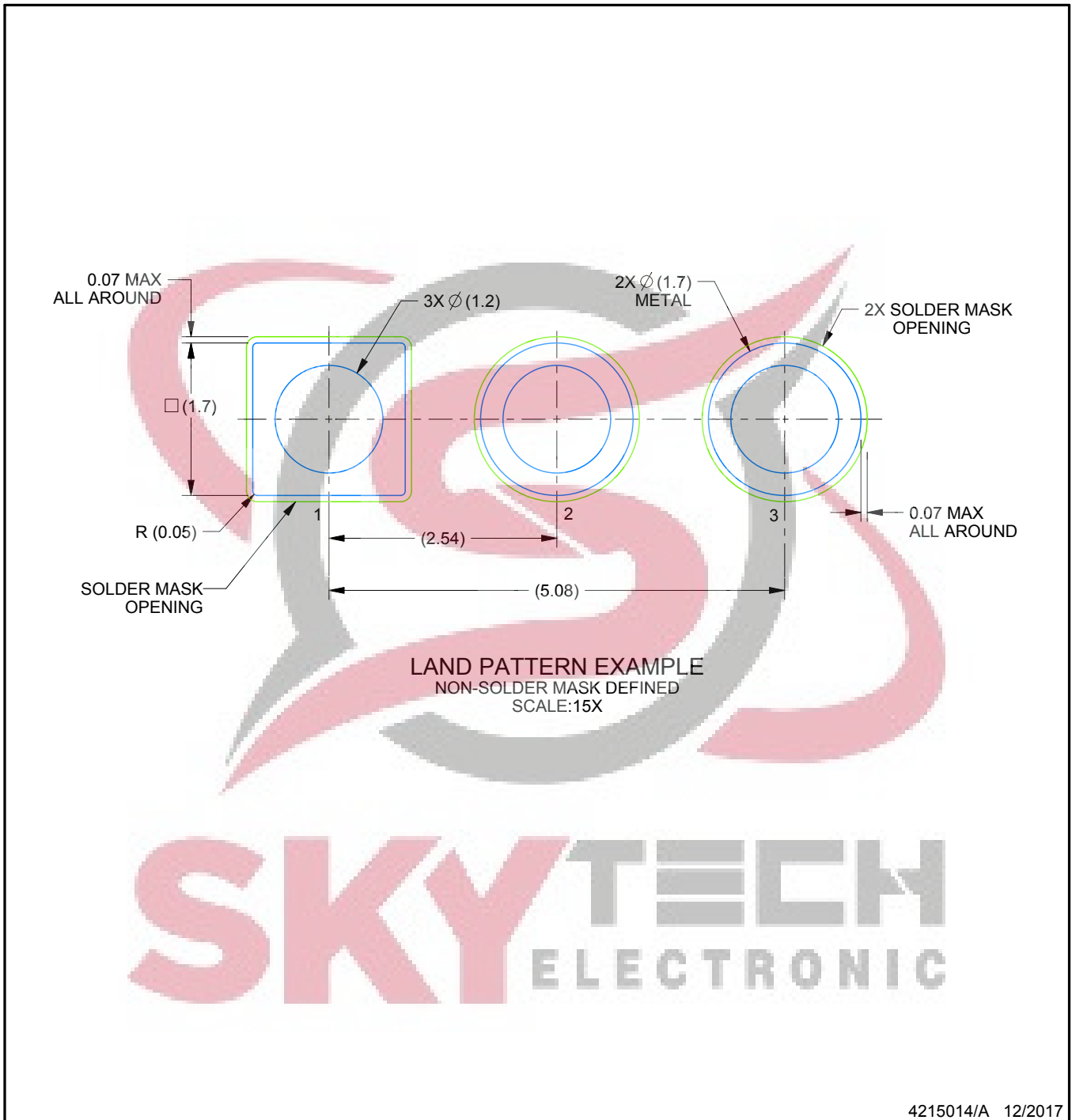



Images above are just a representation of the package family, actual package may vary.  
Refer to the product data sheet for package details.

LP0003A



# PACKAGE OUTLINE

TO-92 - 5.34 mm max height

TO-92

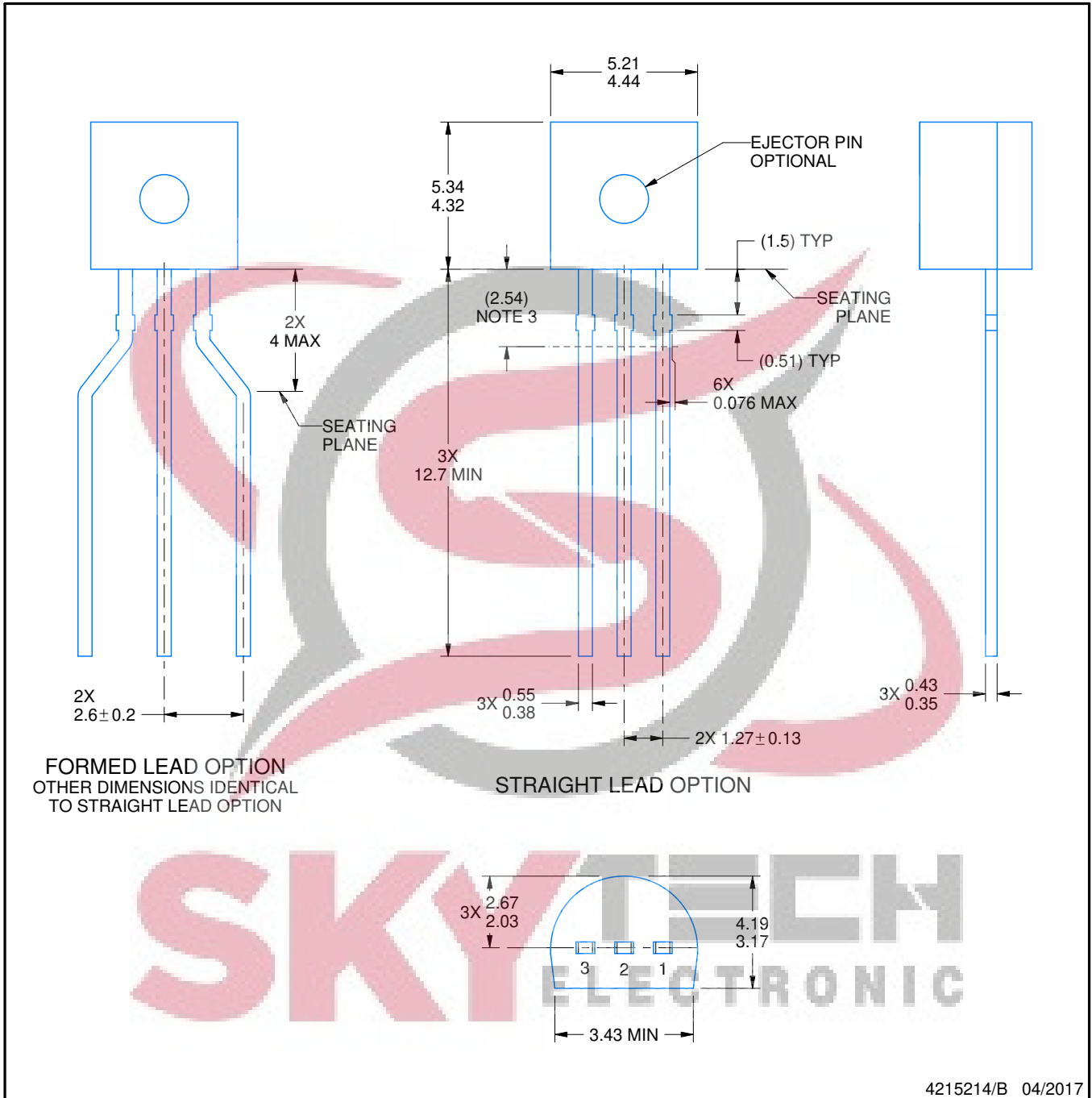

4215214/B 04/2017

**NOTES:**

1. All linear dimensions are in millimeters. Any dimensions in parenthesis are for reference only. Dimensioning and tolerancing per ASME Y14.5M.
2. This drawing is subject to change without notice.
3. Lead dimensions are not controlled within this area.
4. Reference JEDEC TO-226, variation AA.
5. Shipping method:
  - a. Straight lead option available in bulk pack only.
  - b. Formed lead option available in tape and reel or ammo pack.
  - c. Specific products can be offered in limited combinations of shipping medium and lead options.
  - d. Consult product folder for more information on available options.

# EXAMPLE BOARD LAYOUT

LP0003A

TO-92 - 5.34 mm max height

TO-92

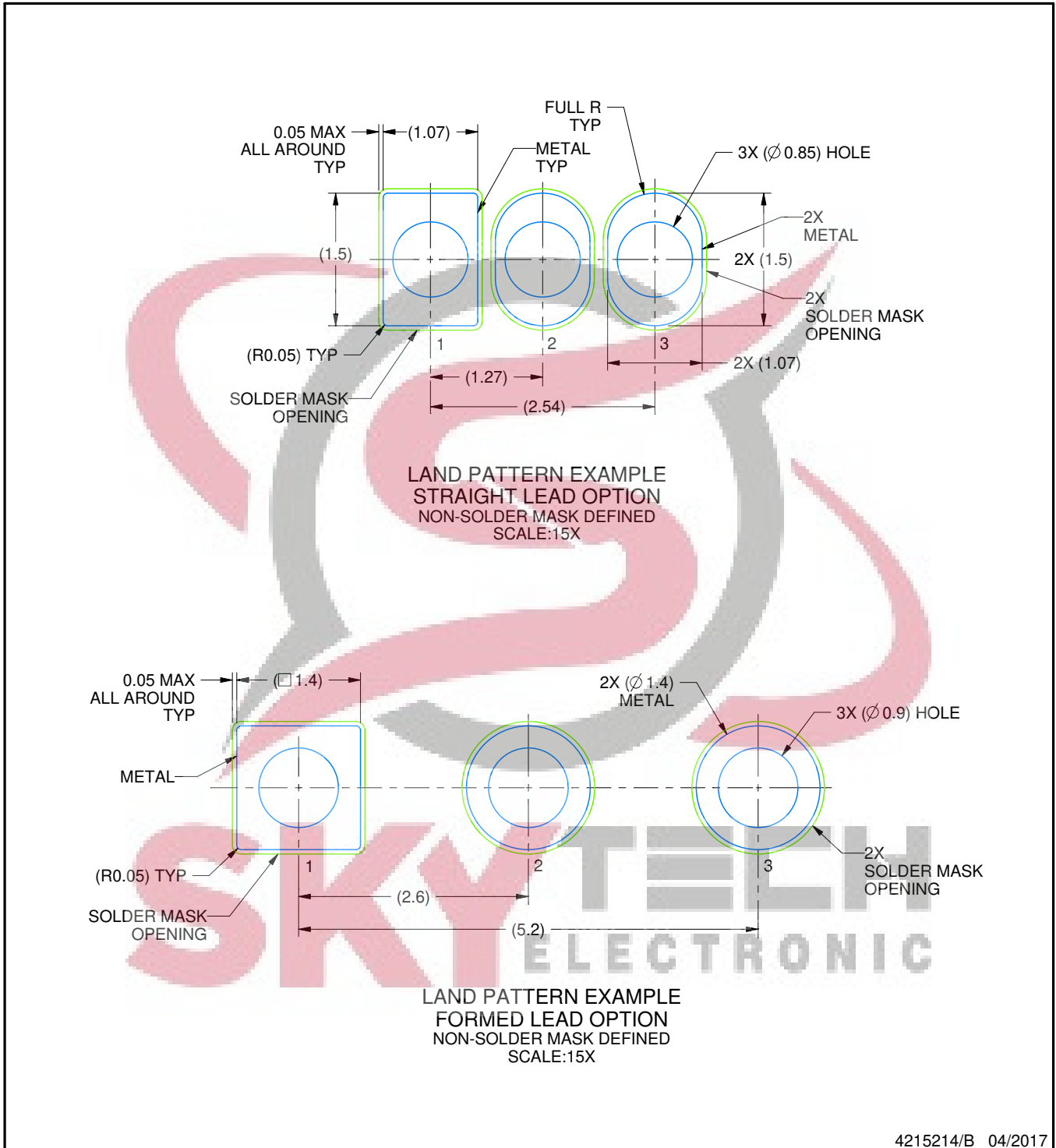

4215214/B 04/2017

TAPE SPECIFICATIONS

LP0003A

TO-92 - 5.34 mm max height

TO-92

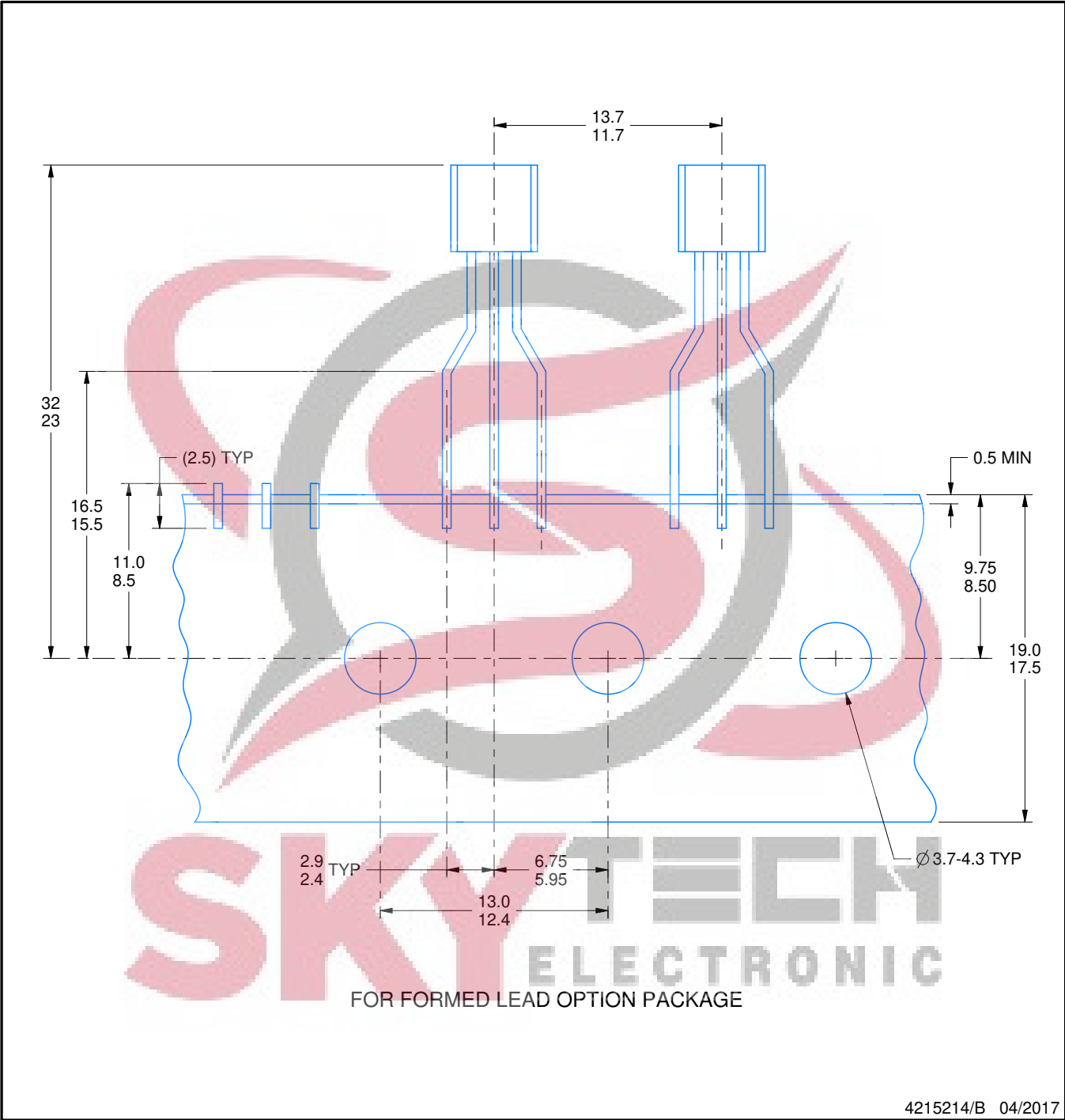

## IMPORTANT NOTICE AND DISCLAIMER

TI PROVIDES TECHNICAL AND RELIABILITY DATA (INCLUDING DATASHEETS), DESIGN RESOURCES (INCLUDING REFERENCE DESIGNS), APPLICATION OR OTHER DESIGN ADVICE, WEB TOOLS, SAFETY INFORMATION, AND OTHER RESOURCES "AS IS" AND WITH ALL FAULTS, AND DISCLAIMS ALL WARRANTIES, EXPRESS AND IMPLIED, INCLUDING WITHOUT LIMITATION ANY IMPLIED WARRANTIES OF MERCHANTABILITY, FITNESS FOR A PARTICULAR PURPOSE OR NON-INFRINGEMENT OF THIRD PARTY INTELLECTUAL PROPERTY RIGHTS.

These resources are intended for skilled developers designing with TI products. You are solely responsible for (1) selecting the appropriate TI products for your application, (2) designing, validating and testing your application, and (3) ensuring your application meets applicable standards, and any other safety, security, or other requirements. These resources are subject to change without notice. TI grants you permission to use these resources only for development of an application that uses the TI products described in the resource. Other reproduction and display of these resources is prohibited. No license is granted to any other TI intellectual property right or to any third party intellectual property right. TI disclaims responsibility for, and you will fully indemnify TI and its representatives against, any claims, damages, costs, losses, and liabilities arising out of your use of these resources.

TI's products are provided subject to TI's Terms of Sale ([www.ti.com/legal/termsofsale.html](http://www.ti.com/legal/termsofsale.html)) or other applicable terms available either on [ti.com](http://ti.com) or provided in conjunction with such TI products. TI's provision of these resources does not expand or otherwise alter TI's applicable warranties or warranty disclaimers for TI products.

Mailing Address: Texas Instruments, Post Office Box 655303, Dallas, Texas 75265  
Copyright © 2020, Texas Instruments Incorporated



**SKYTECH**  
ELECTRONIC